

CRODIOVASCULAR

ALSO AVAILABLE IN TITANIUM

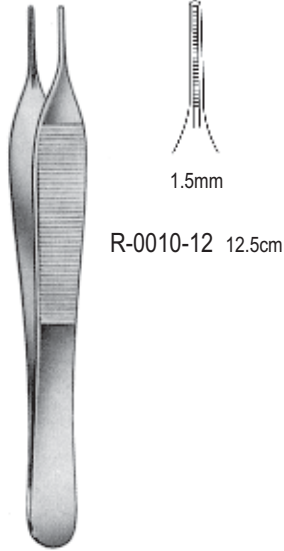

DEBAKEY-ADSON



DEBAKEY-GERALD



1.0mm
 R-0014-15 15.0cm
 R-0014-18 18.0cm



1.2mm
 R-0016-15 15.0cm
 R-0016-18 18.0cm
 R-0016-24 24.0cm

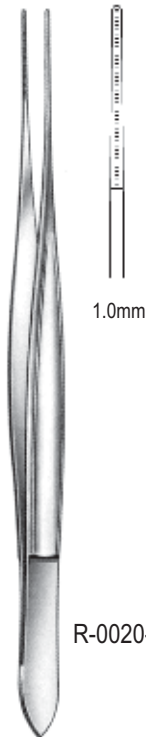

DEBAKEY-CUSHING



DEBAKEY-DIETRICH



1.0mm



1.5mm

R-0024-15 15.0cm R-0026-15
 R-0024-19 19.0cm R-0026-19
 R-0024-24 24.0cm R-0026-24



DEBAKEY-LIGHT



1.0mm

R-0030-15 15.0cm
 R-0030-19 19.0cm
 R-0030-24 24.0cm

CARDIOVASULAR

ALSO AVAILABLE IN TITANIUM



DE BAKEY

- R-0034-16 16.0cm
- R-0034-20 20.0cm
- R-0034-24 24.0cm
- R-0034-30 30.0cm

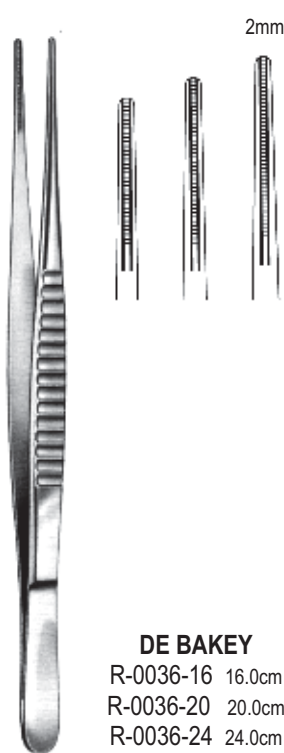

DE BAKEY

- R-0036-16 16.0cm
- R-0036-20 20.0cm
- R-0036-24 24.0cm
- R-0036-30 30.0cm



DE BAKEY

- R-0038-16 16.0cm
- R-0038-20 20.0cm
- R-0038-24 24.0cm
- R-0038-30 30.0cm

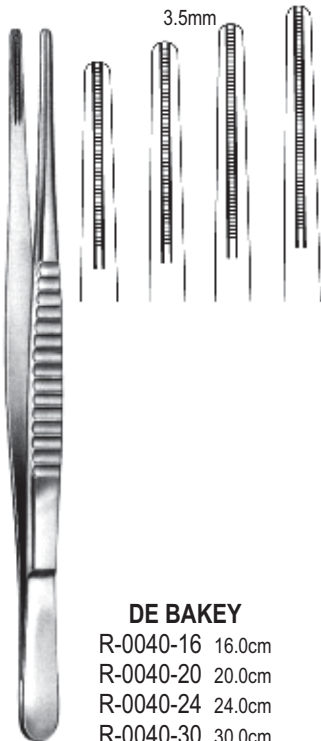

DE BAKEY

- R-0040-16 16.0cm
- R-0040-20 20.0cm
- R-0040-24 24.0cm
- R-0040-30 30.0cm

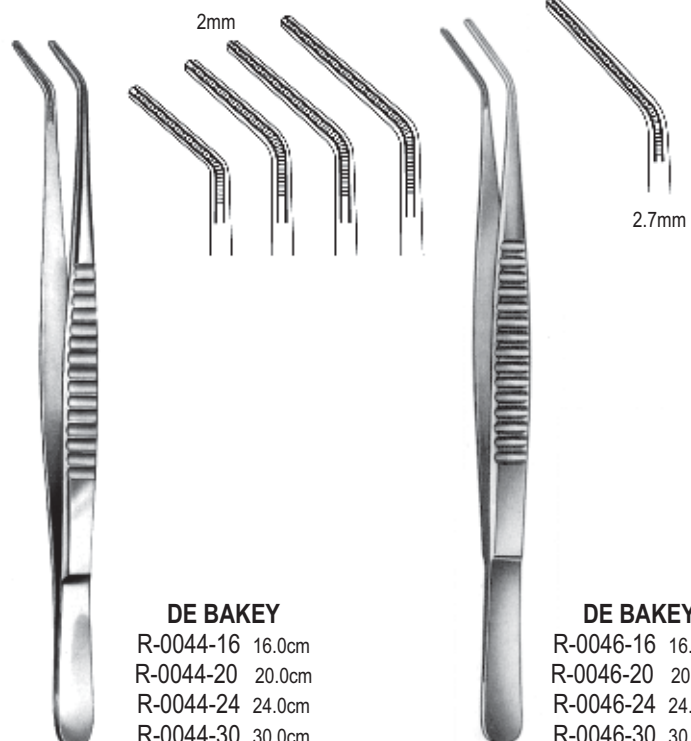

DE BAKEY

- R-0044-16 16.0cm
- R-0044-20 20.0cm
- R-0044-24 24.0cm
- R-0044-30 30.0cm

DE BAKEY

- R-0046-16 16.0cm
- R-0046-20 20.0cm
- R-0046-24 24.0cm
- R-0046-30 30.0cm

CRODIOVASCULAR

ALSO AVAILABLE IN TITANIUM

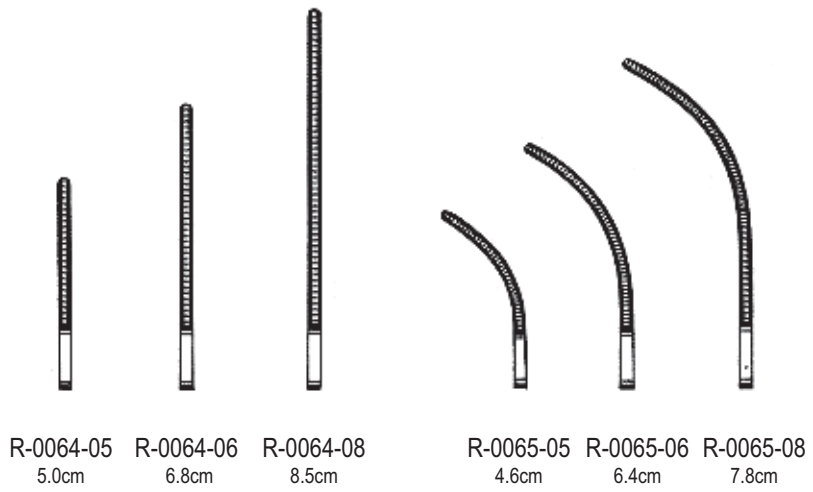
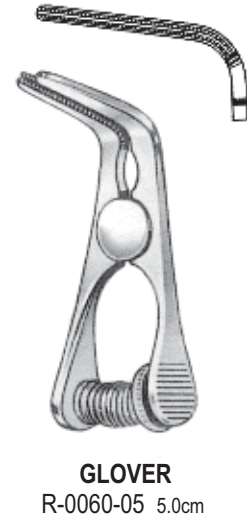
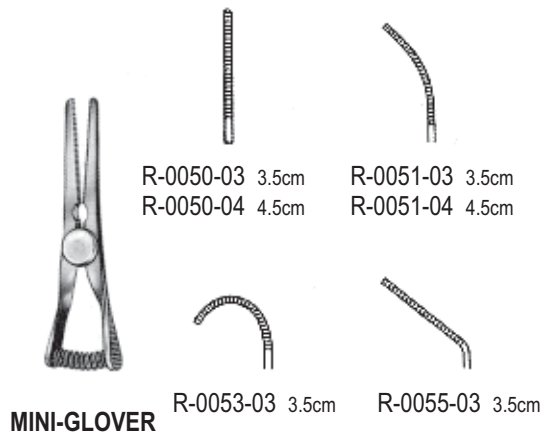

CARDIOVASULAR

ALSO AVAILABLE IN TITANIUM



GLOVER



R-0070-07
7.0cm



R-0070-08
8.0cm



R-0070-09
9.0cm



R-0070-11
11.0cm



GLOVER



R-0071-06
6.0cm



R-0071-07
7.5cm



R-0071-08
8.5cm



R-0071-11
10.5cm

CRODIOVASCULAR

ALSO AVAILABLE IN TITANIUM



DE BAKEY



R-0074-07
7.5cm



R-0074-08
8.5cm



R-0074-10
10.5cm



R-0074-12
12.0cm



DE BAKEY



R-0075-07
7.0cm



R-0075-08
8.0cm



R-0075-10
10.0cm

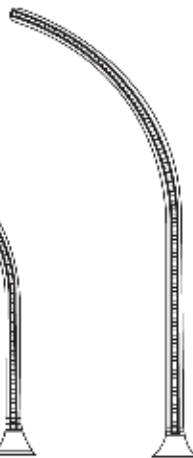

R-0075-11
11.5cm



R-0080-23 23.0cm

CARDIOVASCULAR

ALSO AVAILABLE IN TITANIUM



R-0084-09
9.0cm

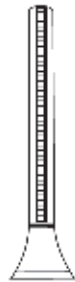

R-0084-11
11.0cm

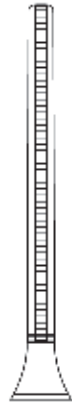

R-0085-09
9.0cm

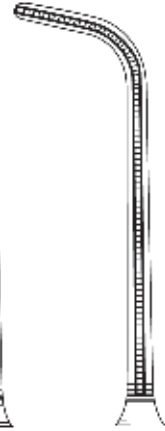

R-0085-11
11.0cm



GREGORY SOFT

GREGORY SOFT



R-0090-01

R-0090-02



SANTULLI
R-0094-07 7.0cm

Atrauma Bulldog Clamps | EN
Atrauma Bulldogklemmen | DE
Atrauma clamps bulldog | ES



CRODIOVASCULAR

ALSO AVAILABLE IN TITANIUM



DE BAKEY-SATINSKY
R-0100-07 7.0cm

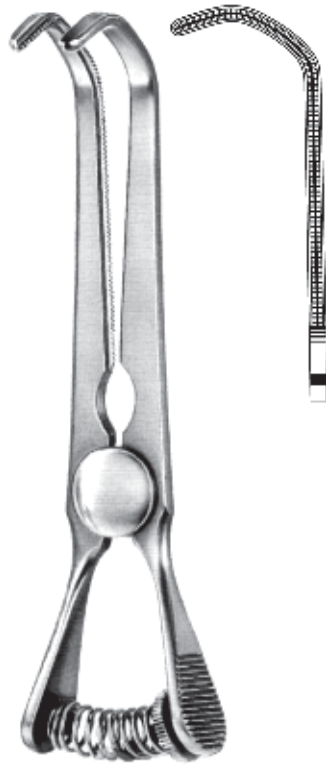

DE BAKEY-SATINSKY
R-0100-10 10.0cm



DE BAKEY-CAROTIS
R-0104-09 9.0cm

CARDIOVASCULAR

ALSO AVAILABLE IN TITANIUM

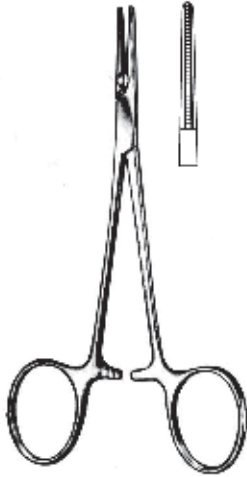

MOSQUITO
R-0110-12 12.0cm



MOSQUITO
R-0111-12 12.0cm



DE BAKEY-MOSQUITO
R-0120-15 15.0cm R-0121-15

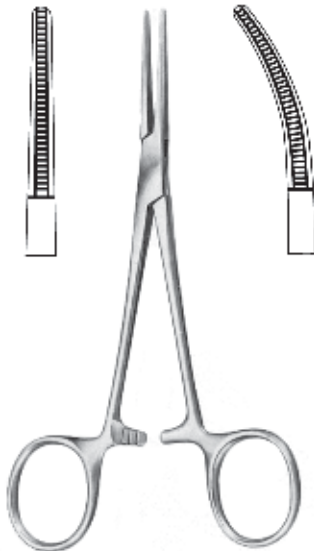

DE BAKEY-KELLY
R-0124-14 14.0cm R-0125-14

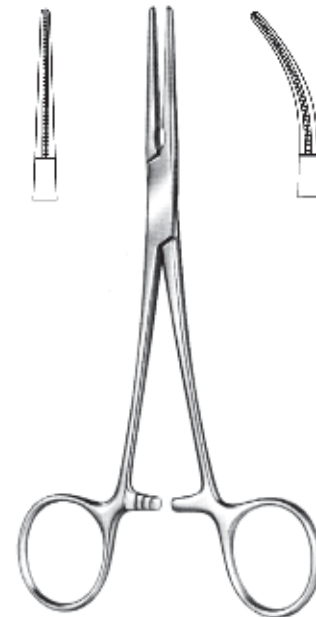

DE BAKEY-RAKIN
R-0130-16 16.0cm R-0131-16

CRODIOVASCULAR

ALSO AVAILABLE IN TITANIUM



DE BAKEY
R-0134-10 10.0cm



DE BAKEY
R-0140-13 13.0cm



DE BAKEY
R-0150-12 12.0cm



DE BAKEY
R-0152-11 11.0cm

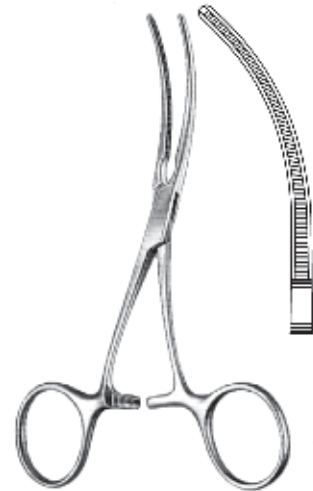

DE BAKEY
R-0154-12 12.0cm



EN | Atrauma Cardiovascular Forceps
DE | Atrauma Cardiovascular-Klemmen
ES | Atrauma pinzas-clamps cardiovasculares

CARDIOVASCULAR

ALSO AVAILABLE IN TITANIUM



HUSFELDT
R-0160-17 17.0cm

HUSFELDT
R-0162-17 17.0cm

HUSFELDT
R-0164-18 18.0cm

CRODIOVASCULAR

ALSO AVAILABLE IN TITANIUM

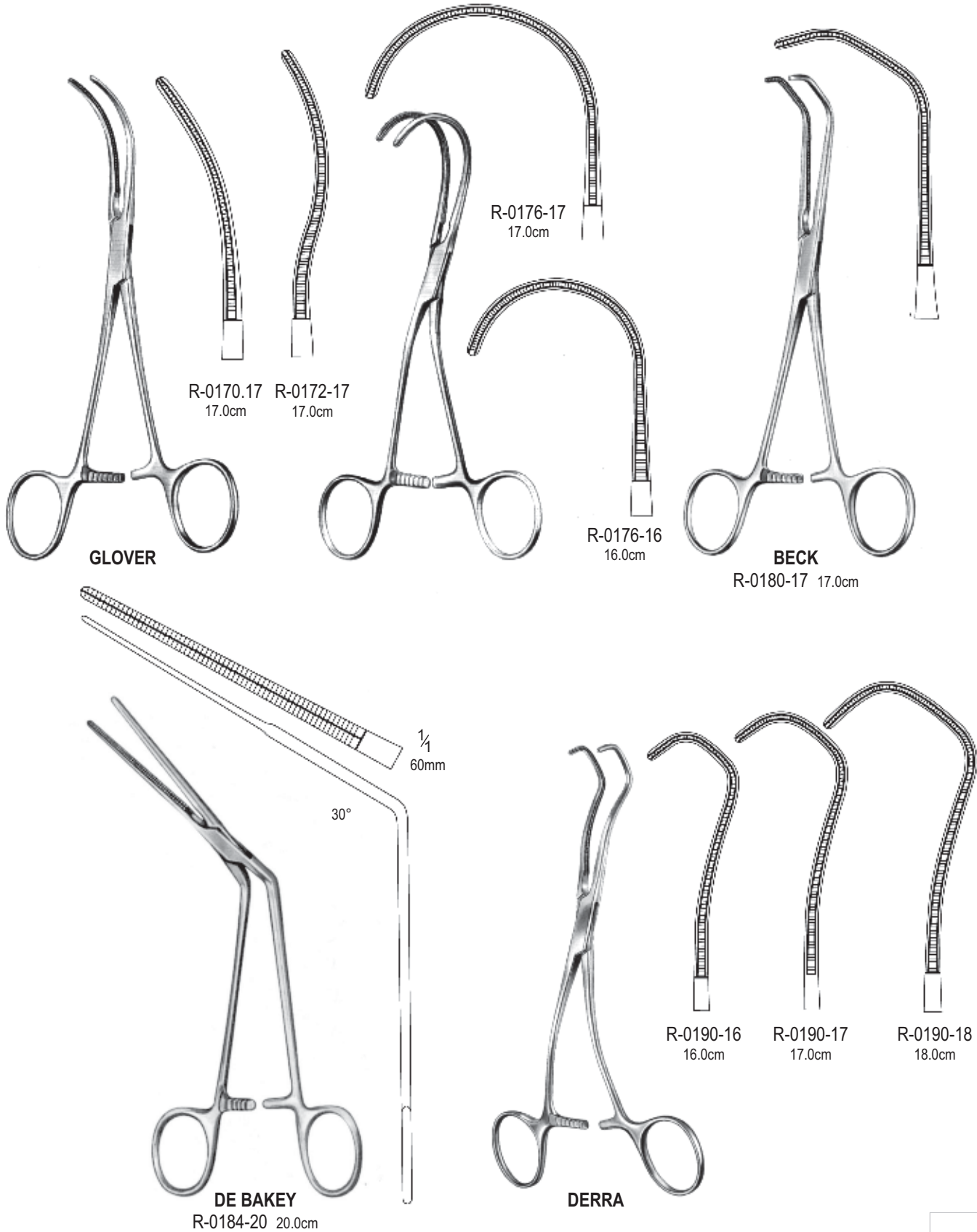



EN | Atrauma Cardiovascular Forceps
DE | Atrauma Cardiovascular-Klemmen
ES | Atrauma pinzas-clamps cardiovasculares

CARDIOVASCULAR

ALSO AVAILABLE IN TITANIUM

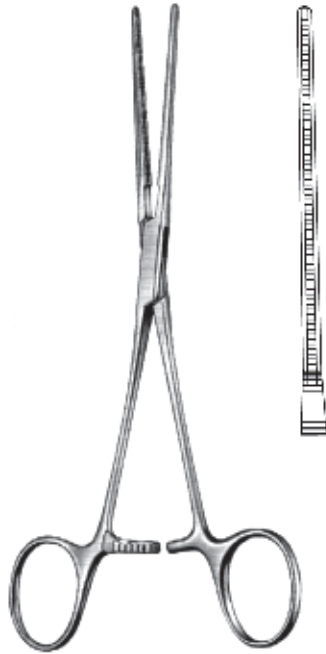

DE BAKEY
R-0194-17 17.0cm



DE BAKEY
R-0200-17 17.0cm



DE BAKEY
R-0204-16 16.0cm

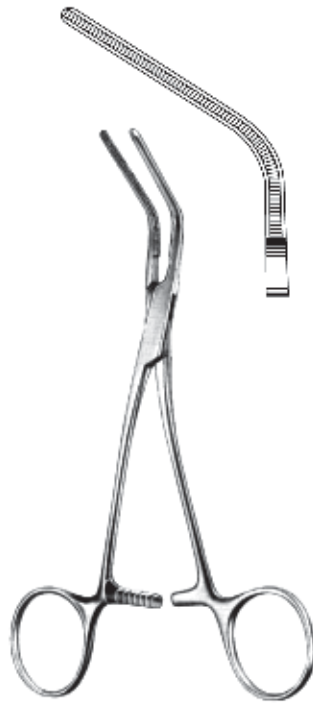

DE BAKEY
R-0210-15 15.0cm



DE BAKEY
R-0214-15 15.0cm

CRODIOVASCULAR

ALSO AVAILABLE IN TITANIUM



DE BAKY-PEAN

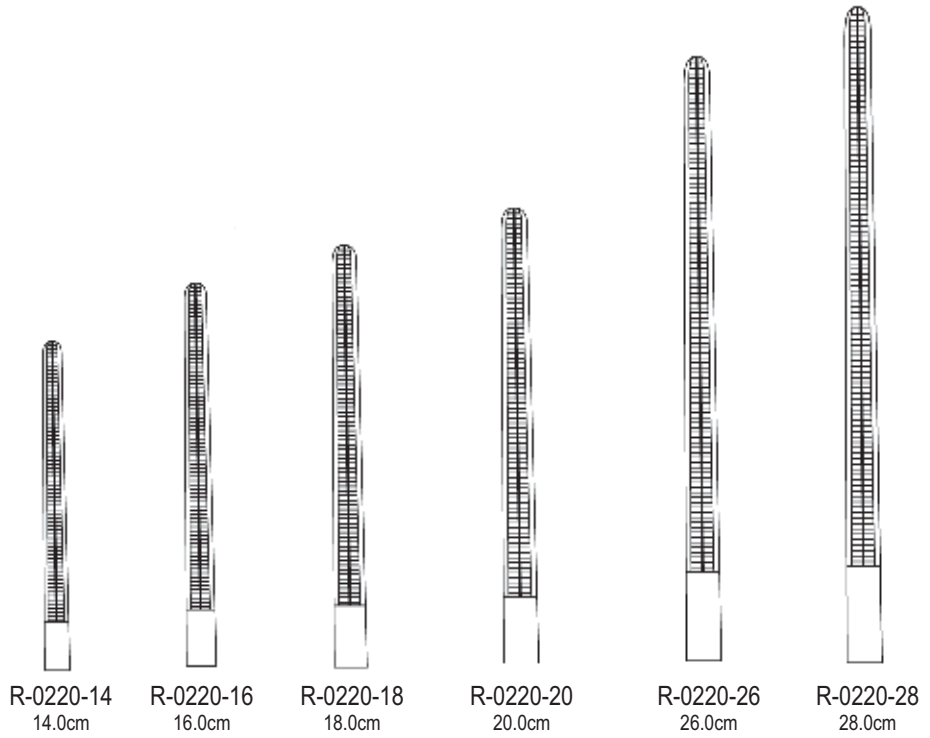

DE BAKY-PEAN

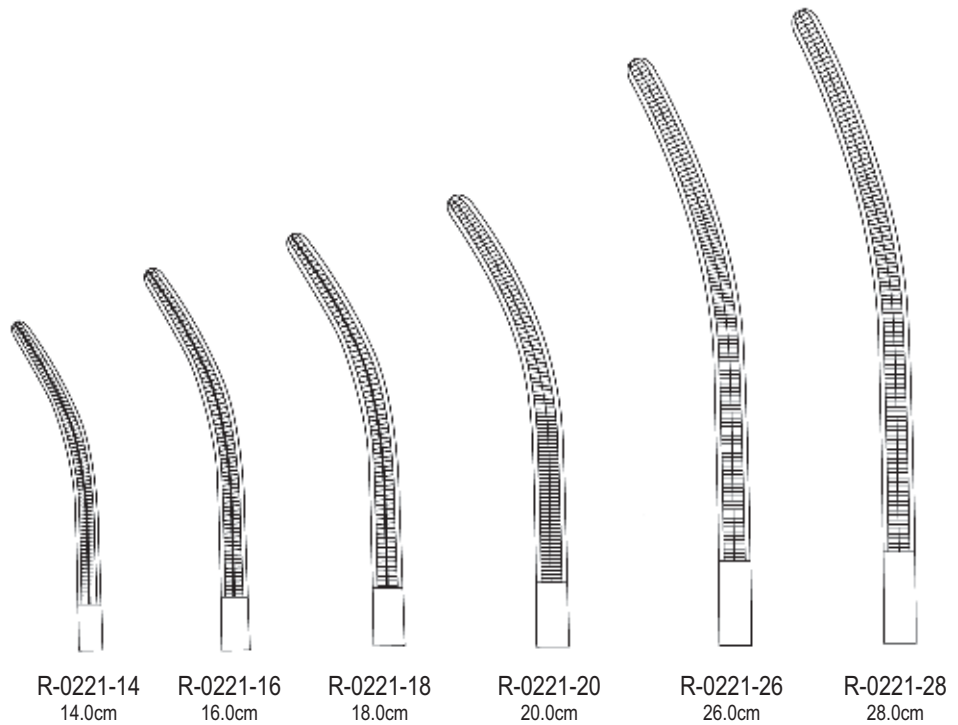

CARDIOVASULAR

ALSO AVAILABLE IN TITANIUM

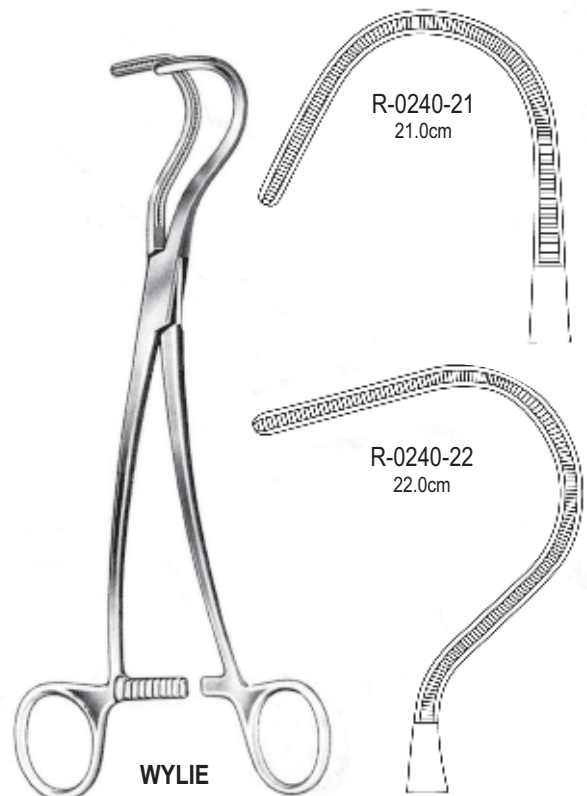
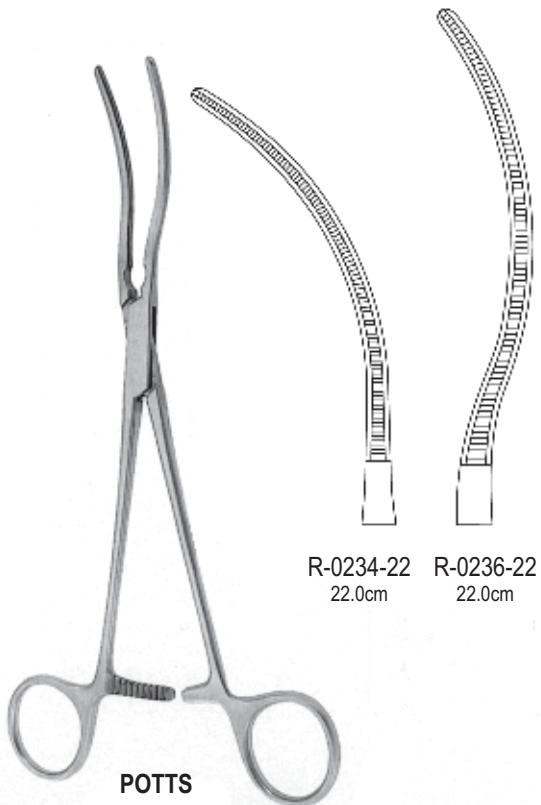
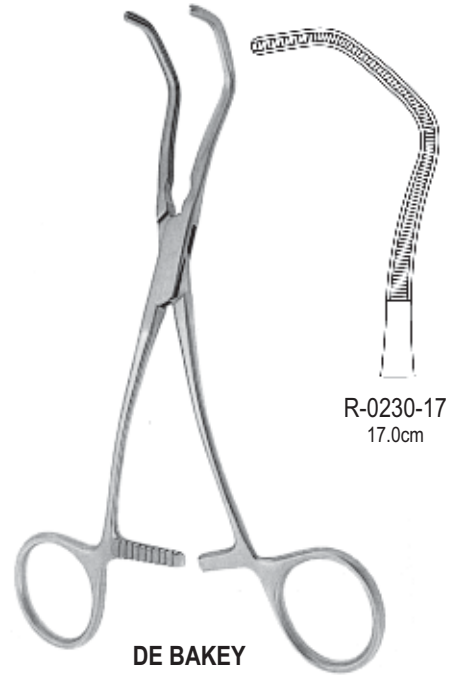
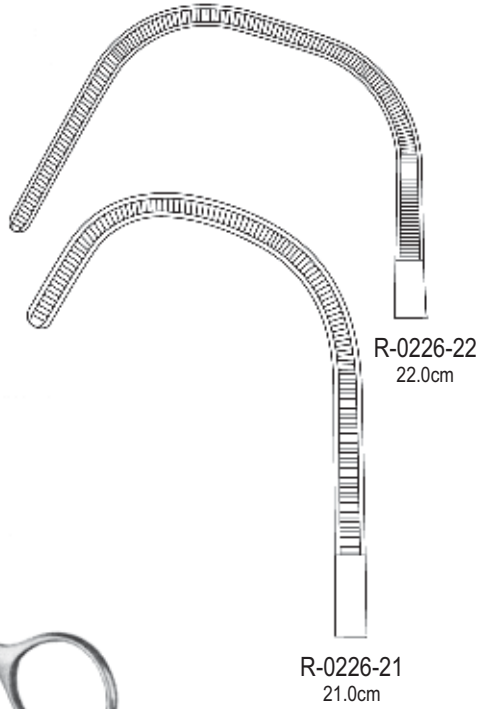

CRODIOVASCULAR

ALSO AVAILABLE IN TITANIUM

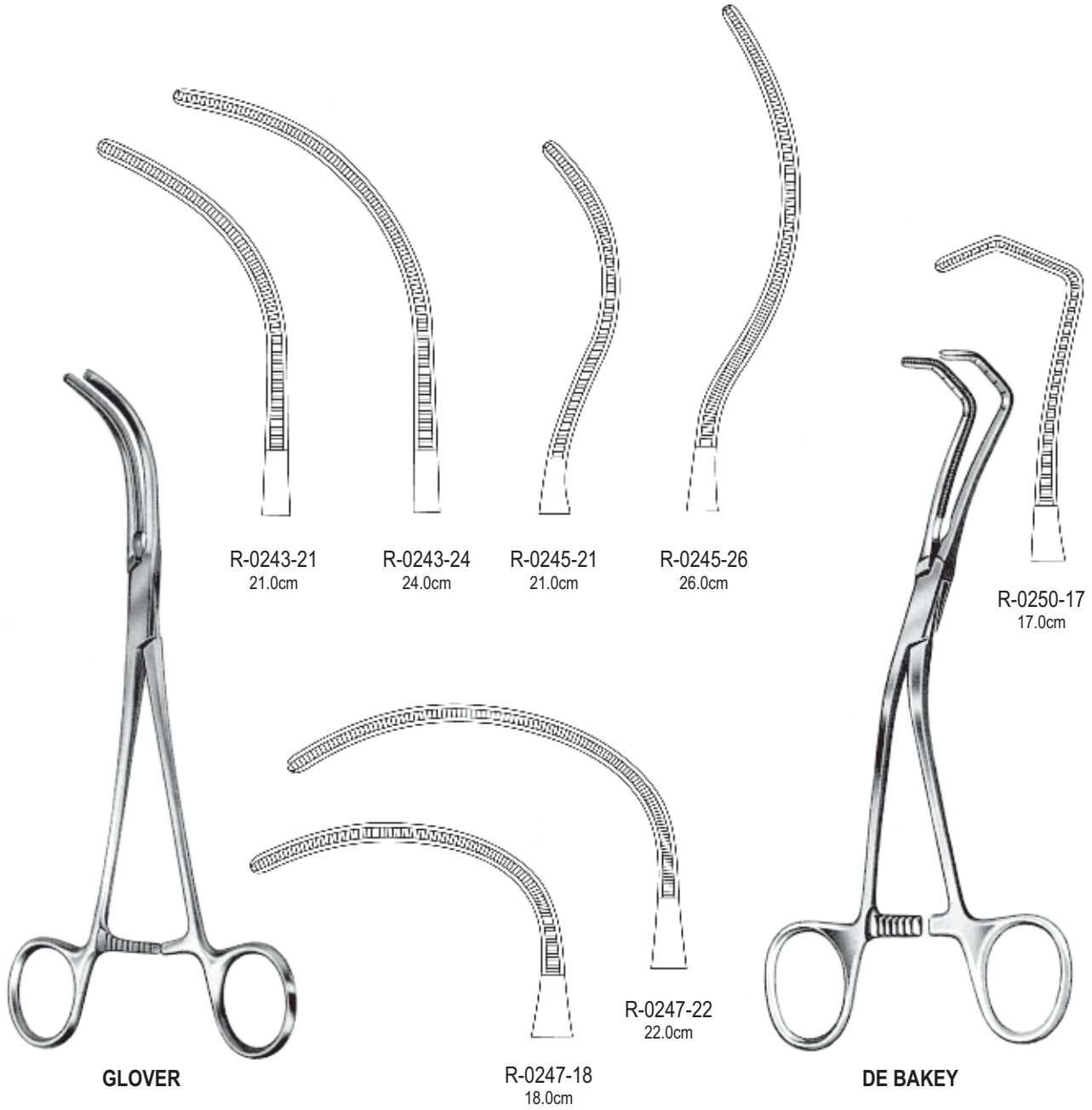

CARDIOVASCULAR

ALSO AVAILABLE IN TITANIUM

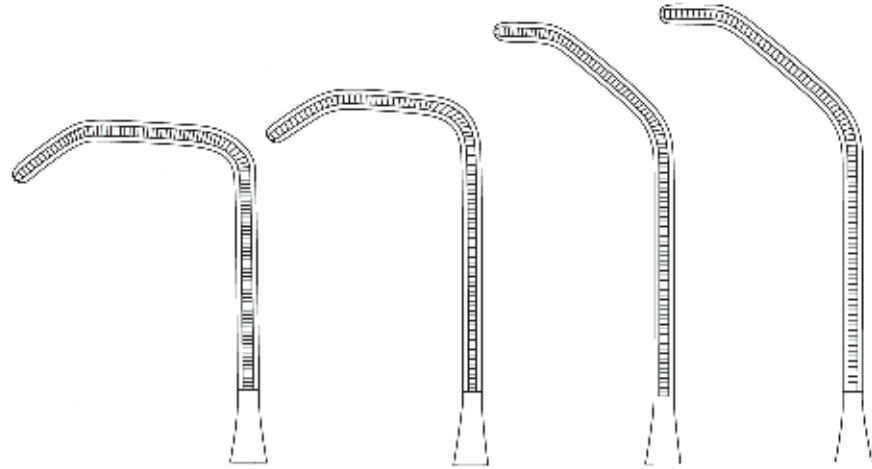

R-0254-16
16.5cm

R-0256-16
16.5cm

R-0254-18
18.0cm

R-0256-18
18.0cm

DE BAKEY-REYNOLDS

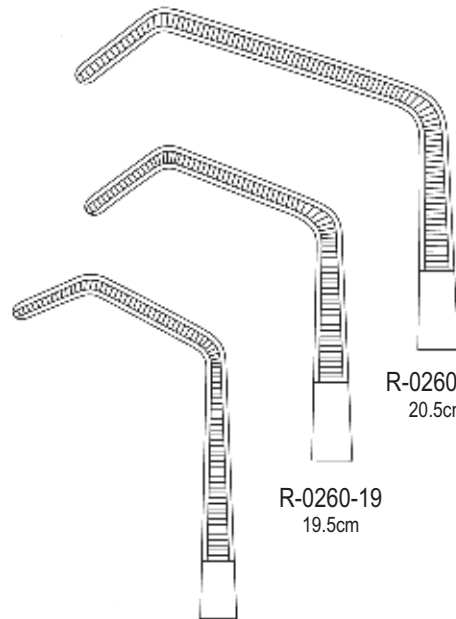

R-0260-16
16.5cm

R-0260-19
19.5cm

R-0260-20
20.5cm

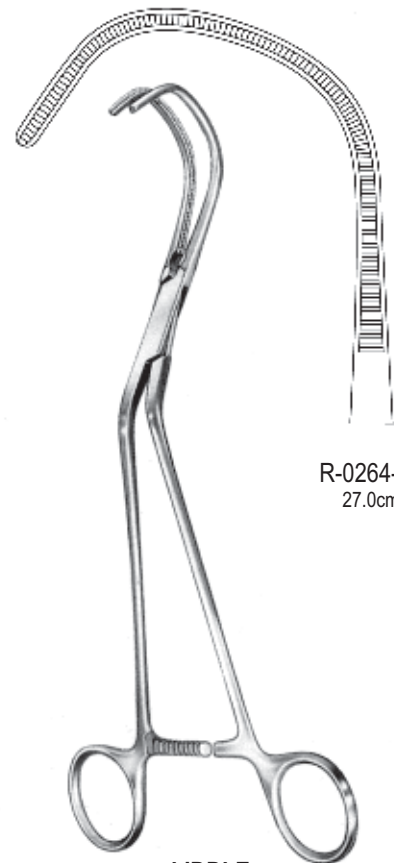

R-0264-27
27.0cm

DE BAKEY-BECK

LIDDLE

Aortic Aneurysm Clamps | EN
Aorta-Aneurysmaklemmen | DE
Pinzas - clamps para aneurisma | ES



CRODIOVASCULAR

ALSO AVAILABLE IN TITANIUM

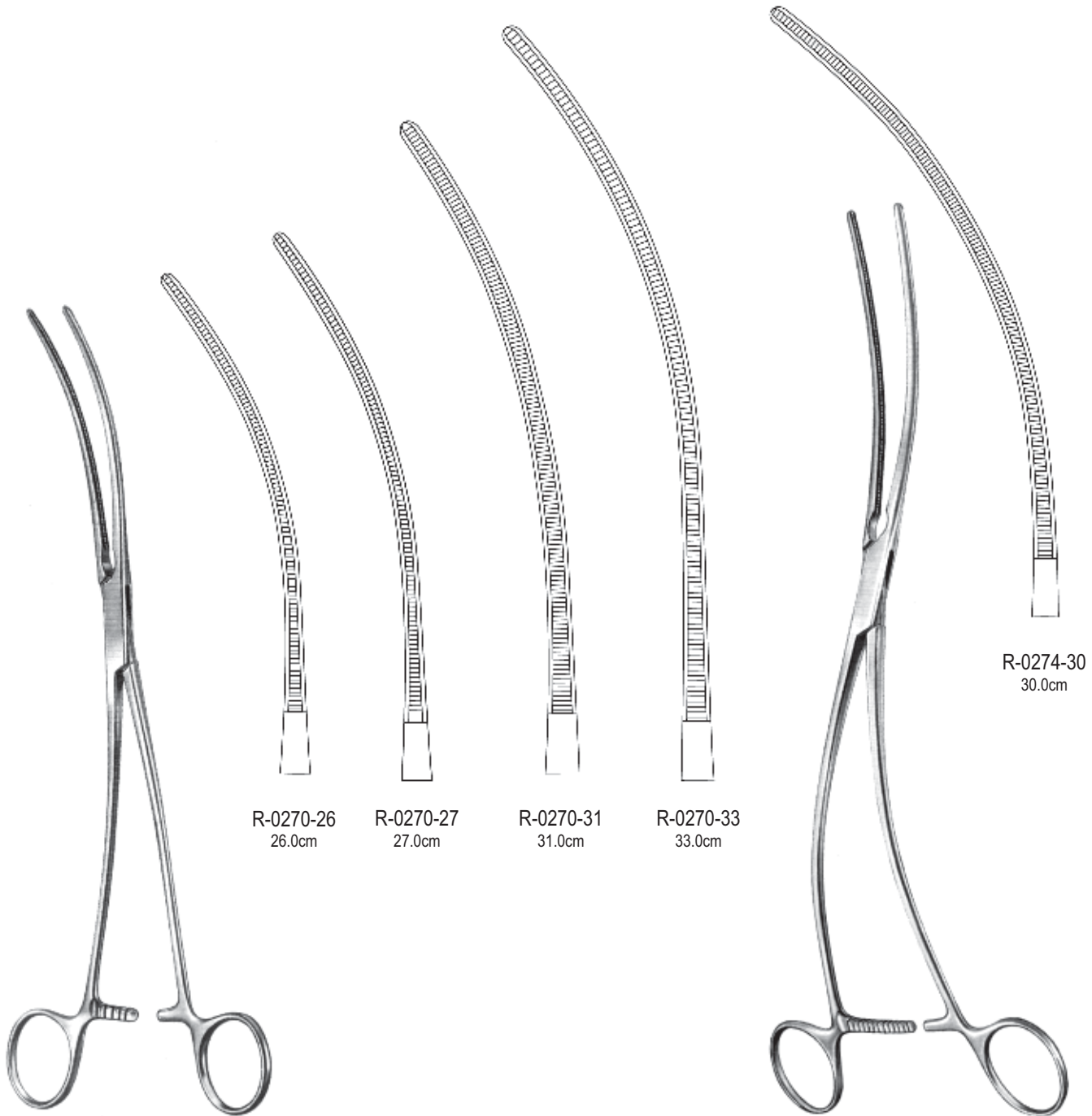

R-0274-30
30.0cm

R-0270-26
26.0cm

R-0270-27
27.0cm

R-0270-31
31.0cm

R-0270-33
33.0cm



EN | Aortic Aneurysm Clamps
DE | Aorta-Aneurysmaklemmen
ES | Pinzas-clamps para aneurisma

CARDIOVASULAR

ALSO AVAILABLE IN TITANIUM

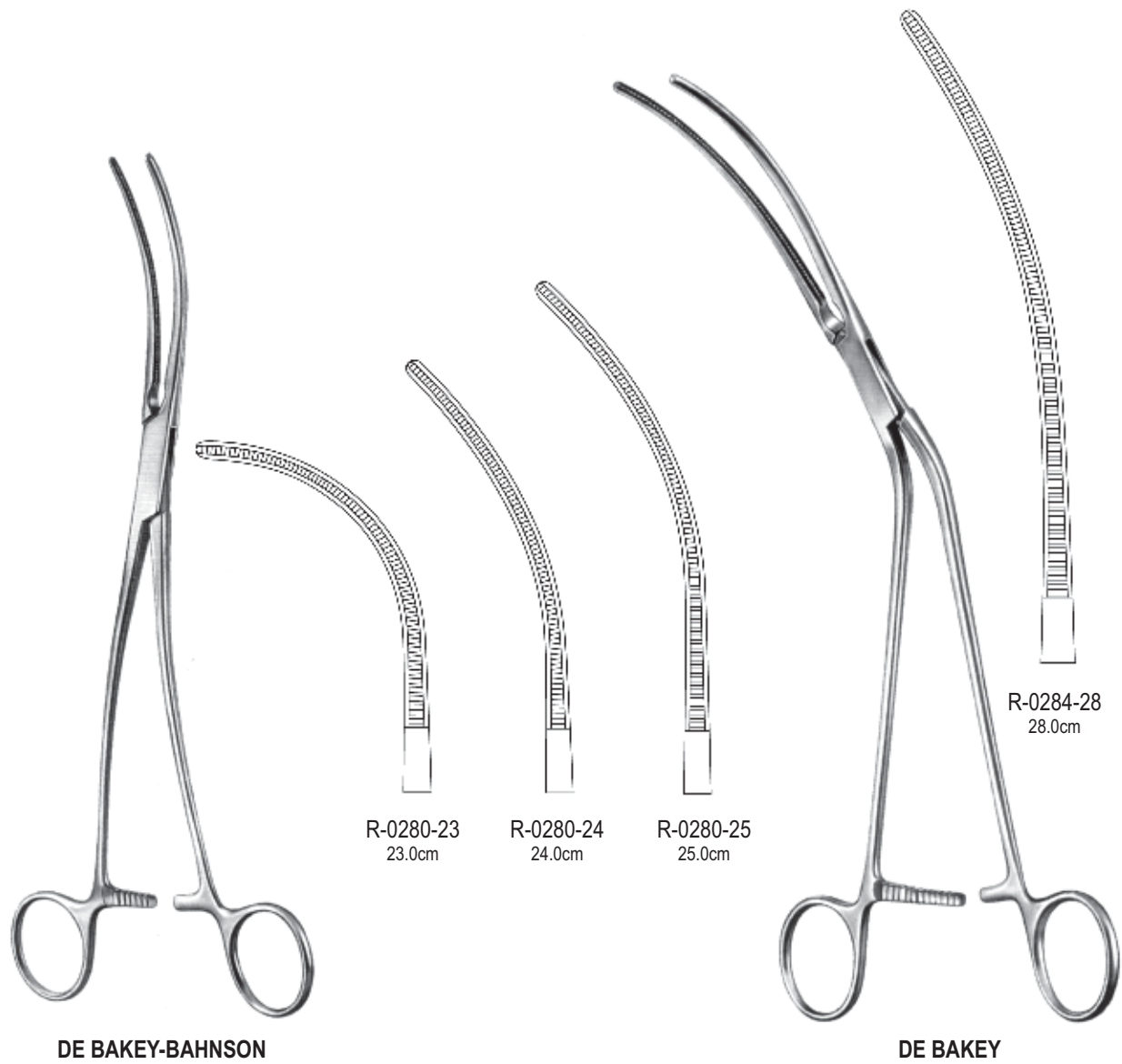

Aortic Clamps | EN
Aortaklemmen | DE
Pinzas-clamps para aorta | ES

dagno
DIAGNOSURGI

CRODIOVASCULAR

ALSO AVAILABLE IN TITANIUM



OCHSNER
R-0290-23 23.5cm
R-0290-26 26.0cm



DIETRICH
R-0294-21 21.0cm

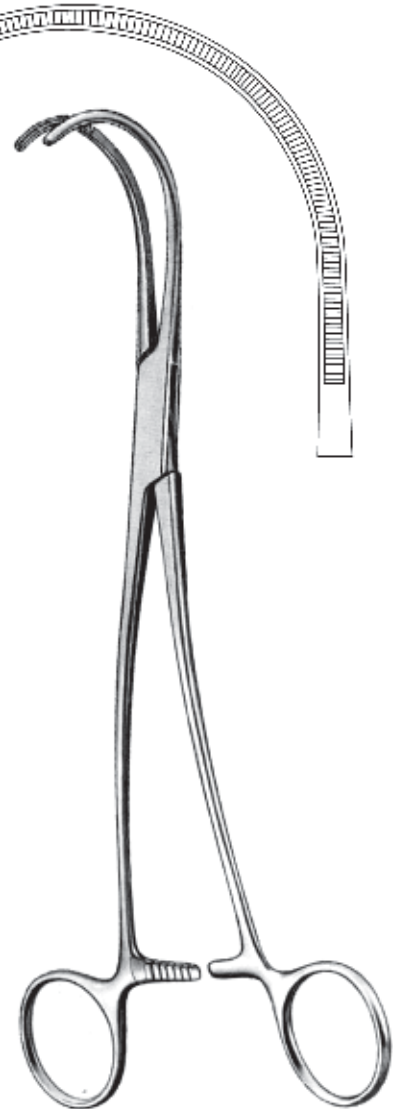

DE BAKAY
R-0300-26 26.0cm

R-019

CARDIOVASULAR

ALSO AVAILABLE IN TITANIUM

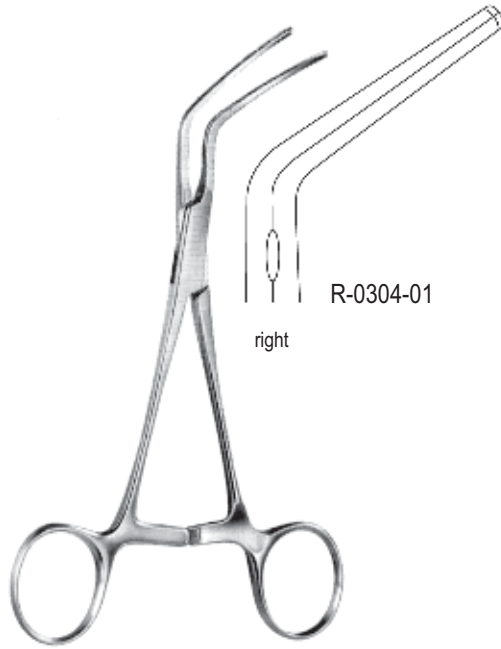

R-0304-01
right

SUBRAMANIAN
16.0cm

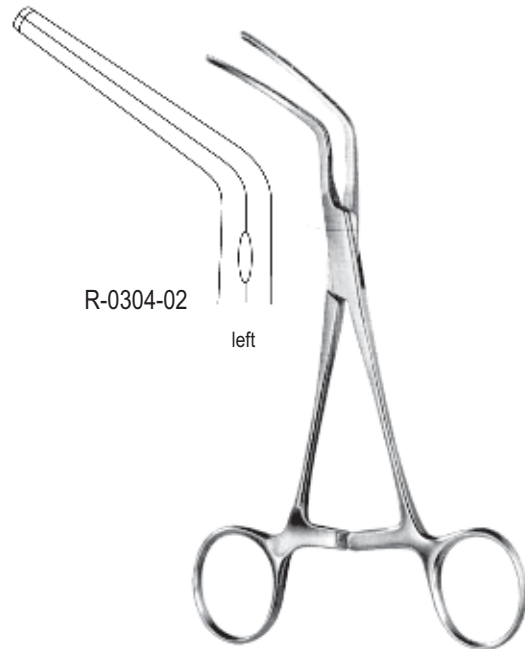

R-0304-02
left

SUBRAMANIAN
16.0cm

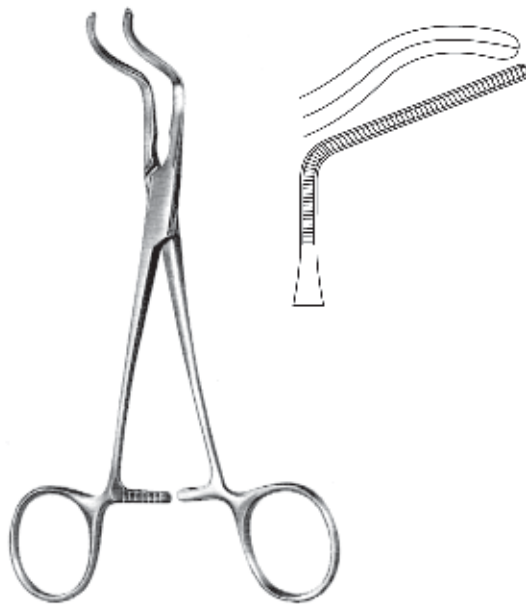

SUBRAMANIAN-MINIATURE
R-0310-15 15.5cm



DE BAKEY
R-0314-27 27.0cm

Aortic Clamps | EN
Aortaklemmen | DE
Pinzas-clamps para aorta | ES



CRODIOVASCULAR

ALSO AVAILABLE IN TITANIUM

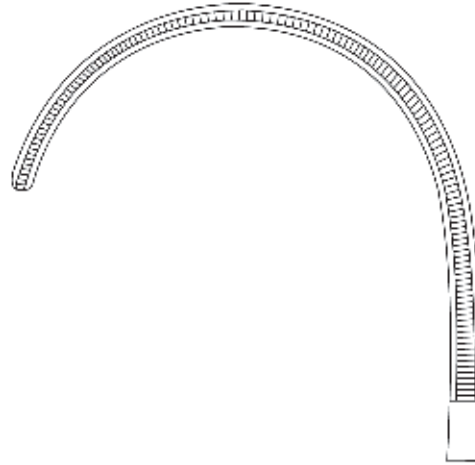
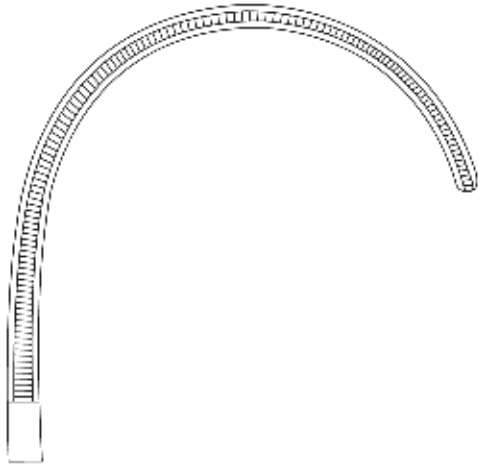

WEBER
R-0320-01 26.0cm



WEBER
R-0320-02 26.0cm



EN | Aortic Clamps
DE | Aortaklemmen
ES | Piznas-clamps para aorta

CARDIOVASULAR

ALSO AVAILABLE IN TITANIUM

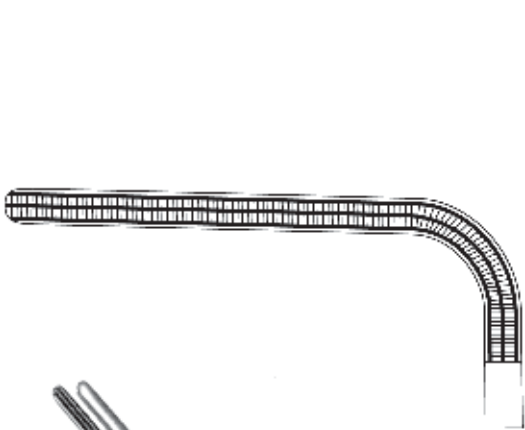

R-0324-18
18.0cm

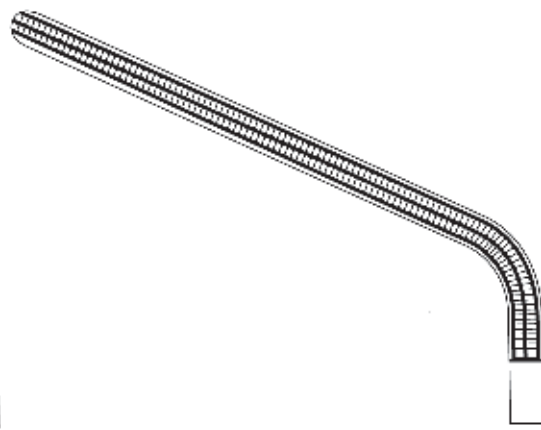

R-0324-20
20.0cm



MORRIS - DE BAKEY

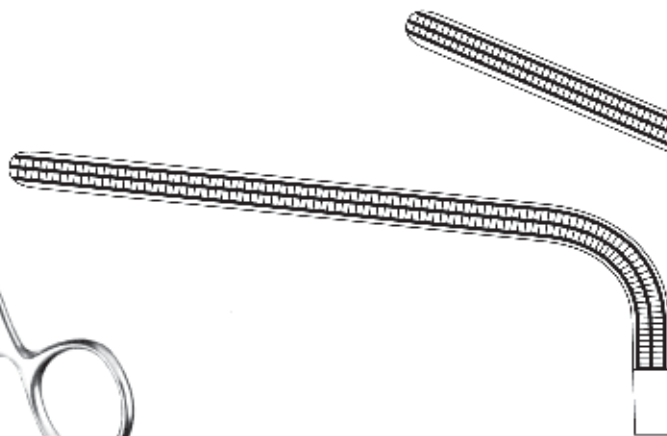

R-0324-23
23.0cm

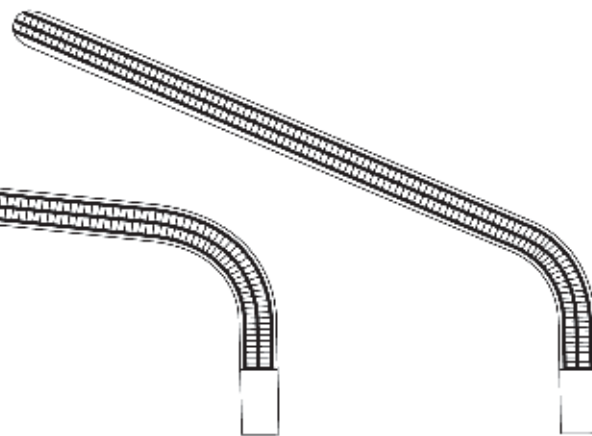

R-0324-25
25.0cm

CRODIOVASCULAR

ALSO AVAILABLE IN TITANIUM



DE BAKEY
SATINSKY



SATINSKY

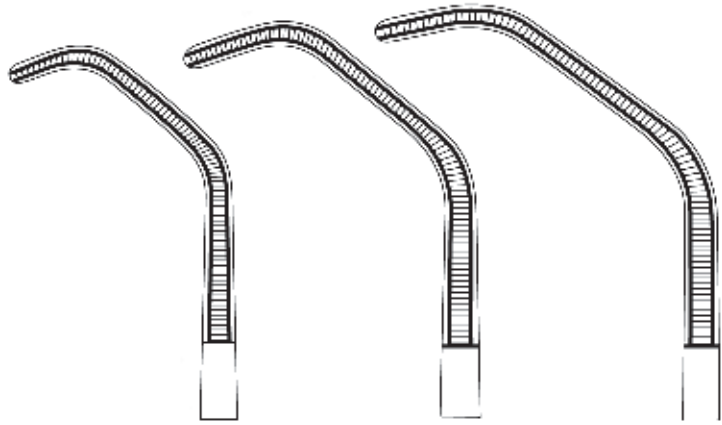
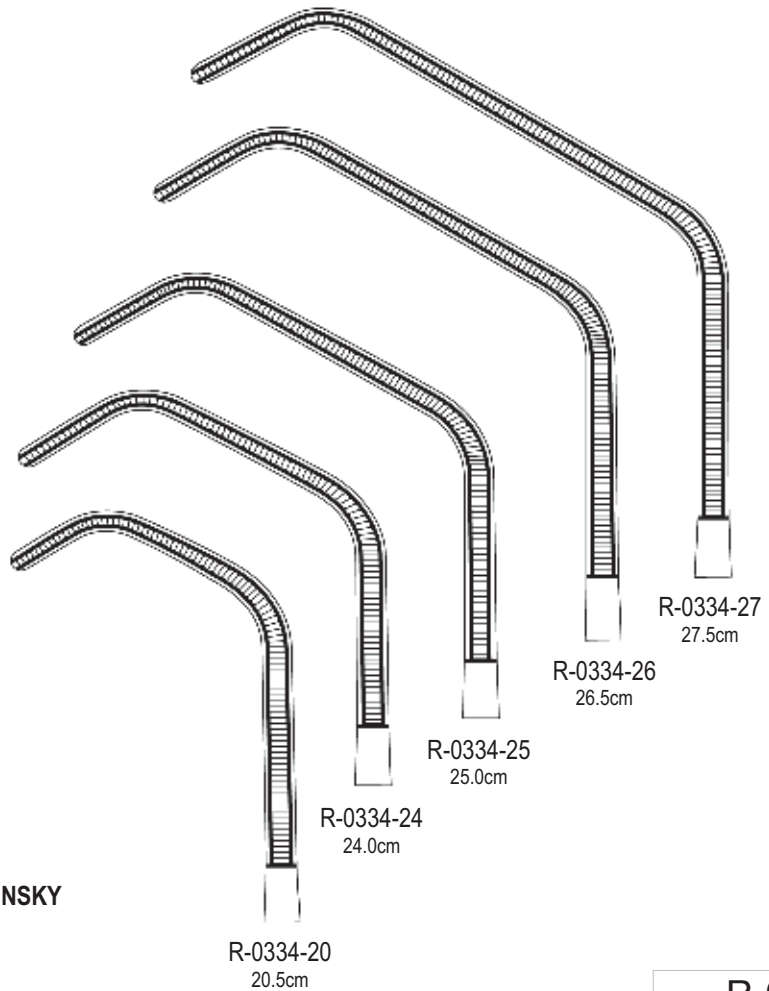

Fig.1 R-0330-23 23.5cm
 Fig.2 R-0330-24 24.0cm
 Fig.3 R-0330-25 25.0cm



R-0334-20 20.5cm
 R-0334-24 24.0cm
 R-0334-25 25.0cm
 R-0334-26 26.5cm
 R-0334-27 27.5cm

CARDIOVASCULAR

ALSO AVAILABLE IN TITANIUM

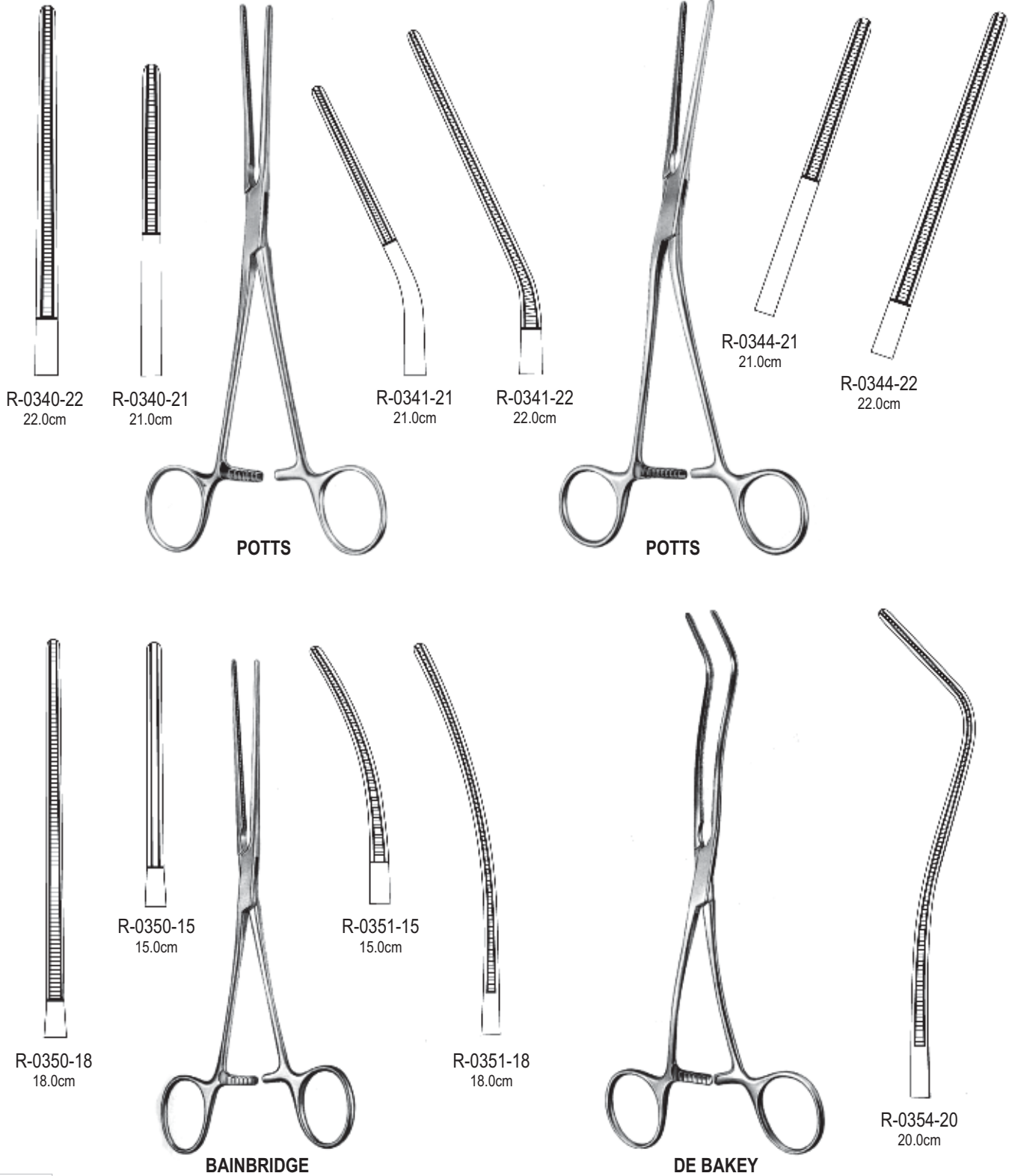

Profunda Clamps, Peripheral Vascular Clamps | EN
Profundaklemmen, Peripheral-Gefaßklemmen | DE
Pinzas-clamps para la profunda, pinzas-clamps para vasos perifericosl | ES



CRODIOVASCULAR

ALSO AVAILABLE IN TITANIUM



GREGORY



R-0360-14
14.0cm



R-0360-16
16.0cm



R-0360-18
18.0cm

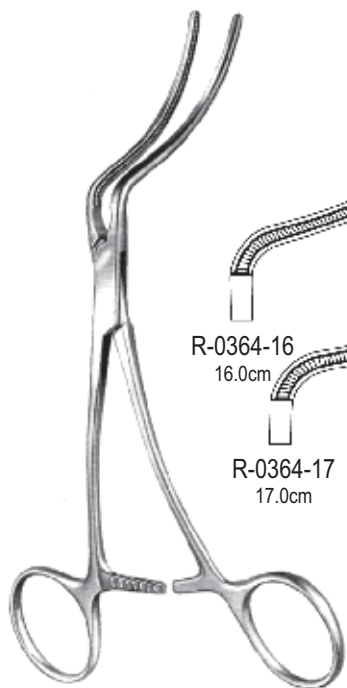

R-0364-16
16.0cm

R-0364-17
17.0cm

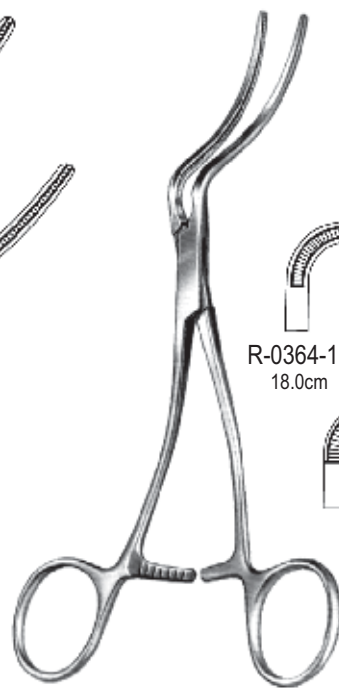

R-0364-18
18.0cm

R-0364-20
20.0cm

CARDIOVASCULAR

ALSO AVAILABLE IN TITANIUM

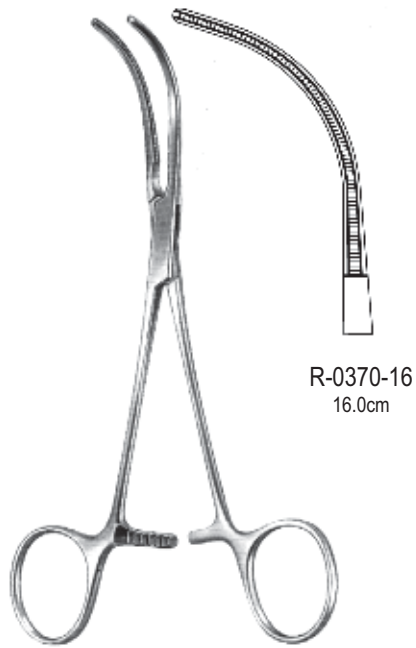

R-0370-16
16.0cm

DE BAKEY

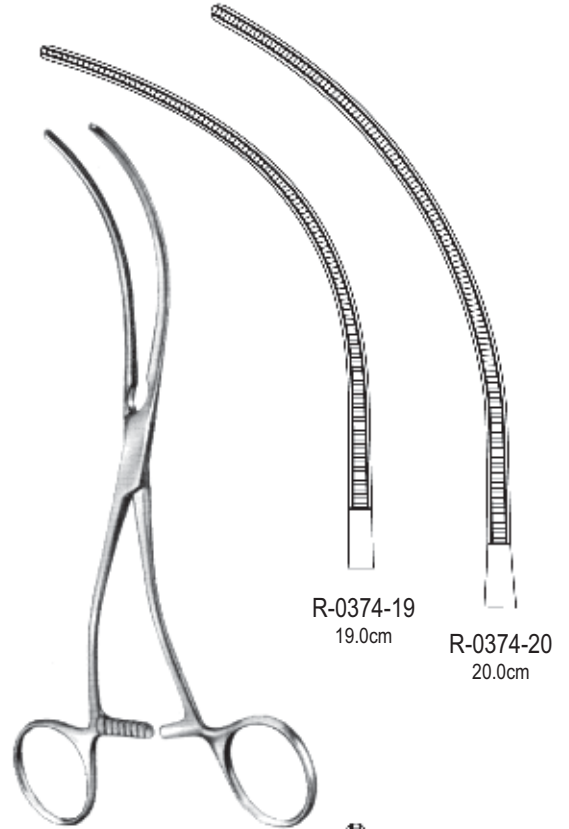

R-0374-19
19.0cm

R-0374-20
20.0cm

DE BAKEY

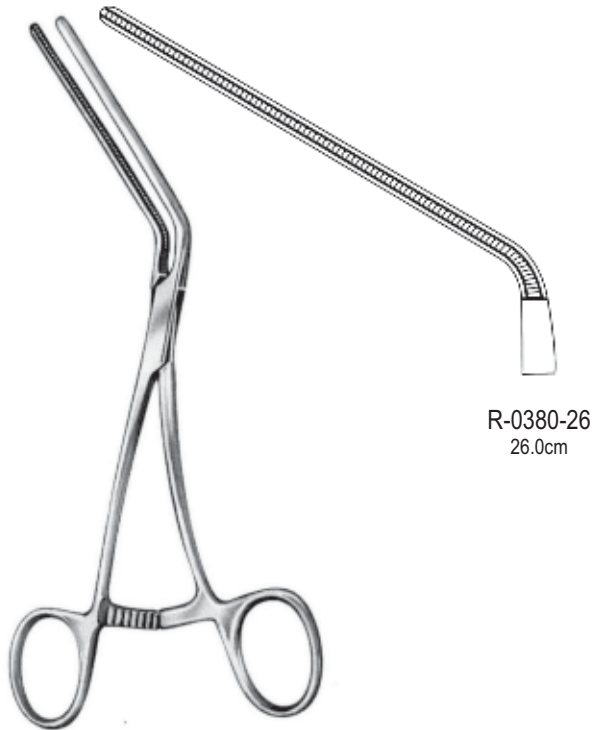

R-0380-26
26.0cm

DE BAKEY

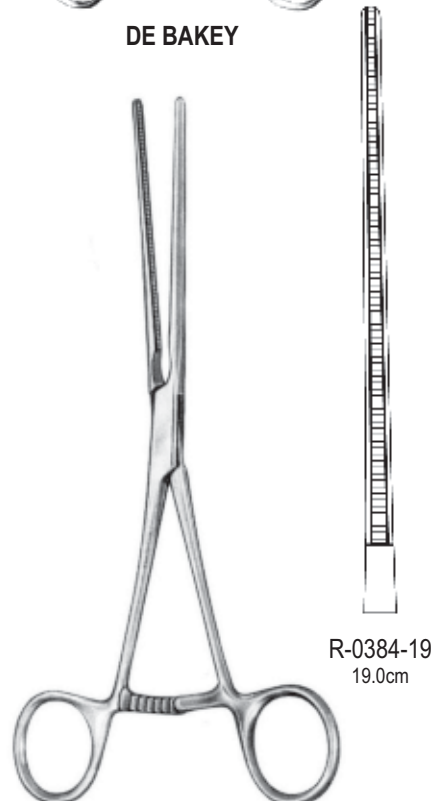

R-0384-19
19.0cm

LELAND JONES

CRODIOVASCULAR

ALSO AVAILABLE IN TITANIUM



LELAND JONES



R-0390-18
18.0cm

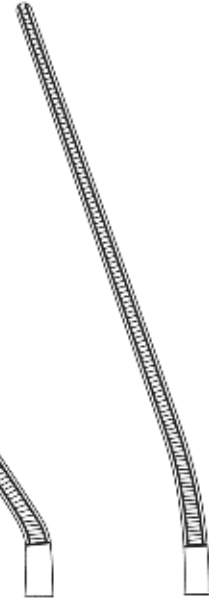

R-0390-19
19.0cm

R-0390-20
20.0cm

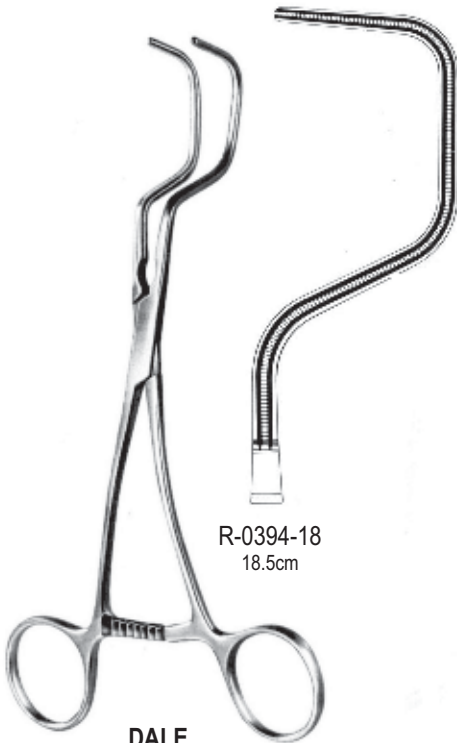

DALE

R-0394-18
18.5cm



DALE

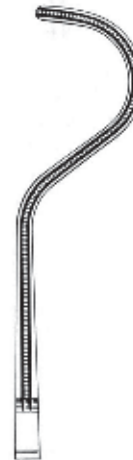

R-0400-17
17.0cm



R-0400-18
18.0cm

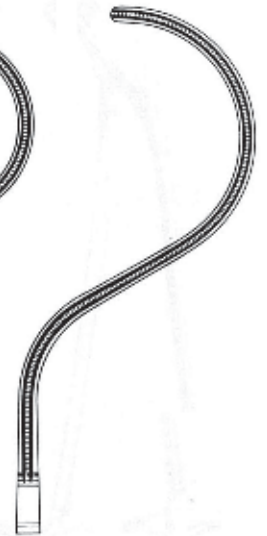

R-0400-19
19.0cm

CARDIOVASCULAR

ALSO AVAILABLE IN TITANIUM



DE BAKEY



R-0404-19
19.0cm



R-0404-23
23.0cm



R-0410-24
24.0cm



R-0414-24
24.0cm



R-0414-25
25.0cm



DE BAKEY



DE BAKEY



DE BAKEY

Auricle Clamps, Bronchus Clamps | EN
Aurikeklemmen, Bronchusklemmen | DE
Pinzas clamps para auricula, pinzas clamps bronquiales | ES



CRODIOVASCULAR

ALSO AVAILABLE IN TITANIUM



HARKEN
24.0cm

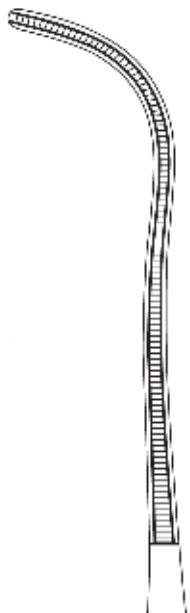

R-0420-01

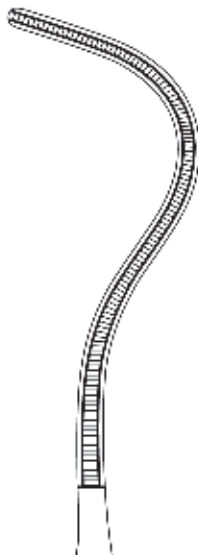

R-0420-02

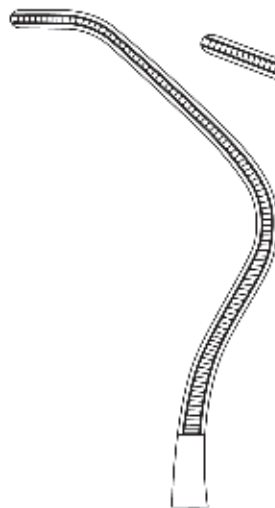

R-0420-03

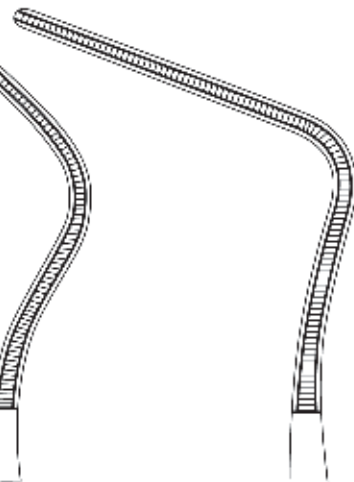

R-0420-04



LEES

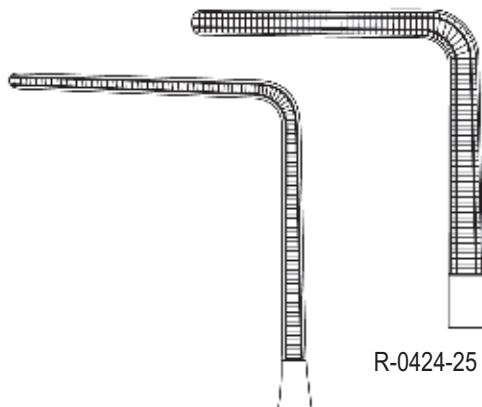

R-0424-23 23.0cm

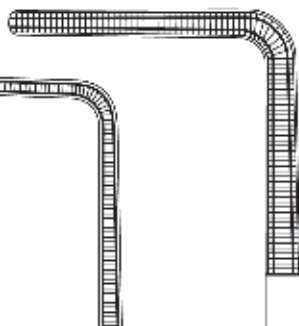

R-0424-25 25.0cm



LEES

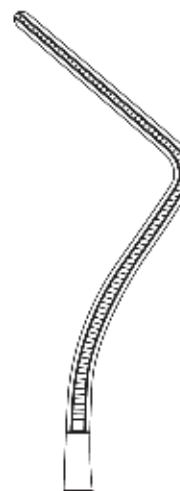

R-0430-25 25.0cm

CARDIOVASULAR

ALSO AVAILABLE IN TITANIUM



R-0434-21
21.0cm



R-0434-23
23.0cm



R-0434-27
27.0cm



R-0434-31
31.0cm

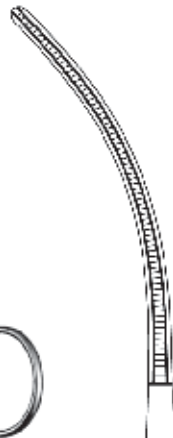

R-0435-21
21.0cm



R-0435-23
23.0cm

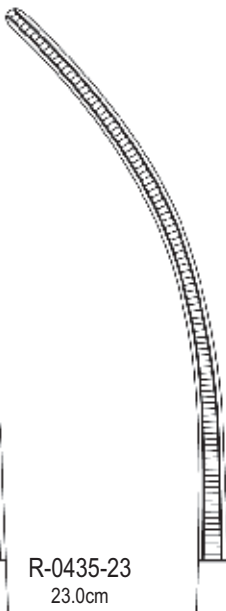

R-0435-27
27.0cm

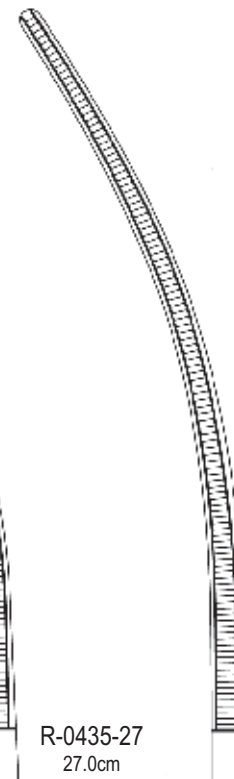

R-0435-31
31.0cm

Multi Purpose Clamps | EN
Mehrzweckklemmen | DE
Pinzas-clamps para usos varios | ES



CRODIOVASCULAR

ALSO AVAILABLE IN TITANIUM



DE BAKEY

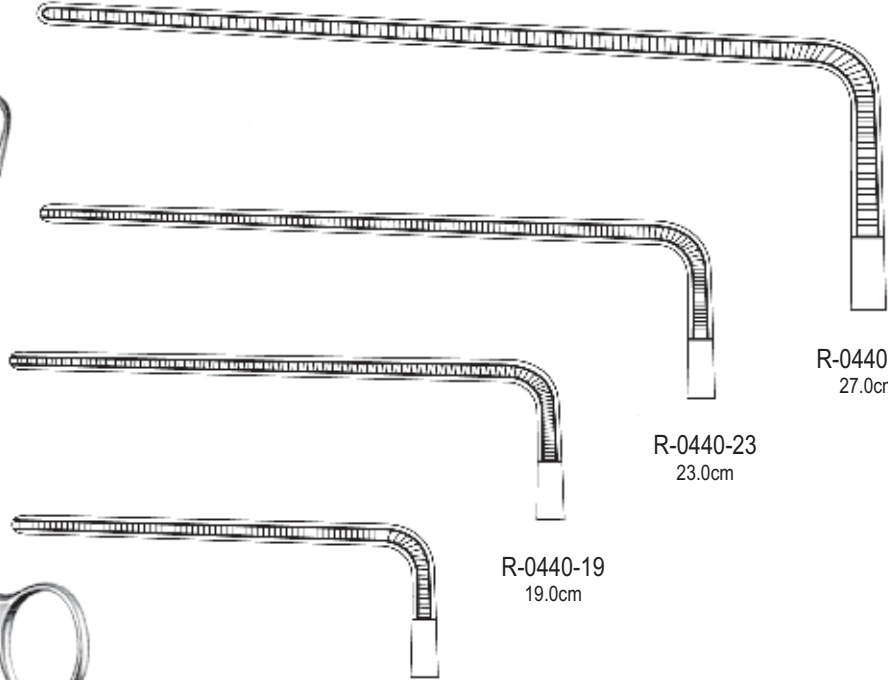

R-0440-27
27.0cm

R-0440-23
23.0cm

R-0440-19
19.0cm

35-0440-18
18.0cm



DE BAKEY



R-0444-20
20.0cm

R-0444-21
21.0cm

R-0444-25
25.0cm

35-0444-29
29.0cm

R-031

CARDIOVASCULAR

ALSO AVAILABLE IN TITANIUM

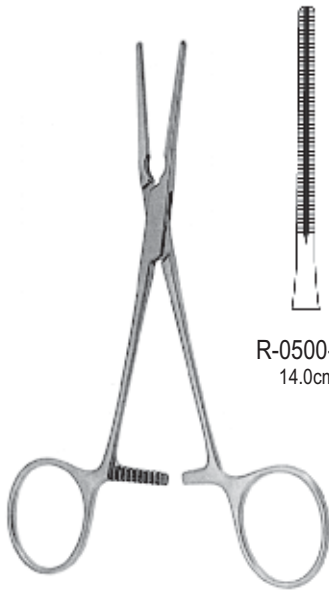

R-0500-01
14.0cm

COOLEY



R-0500-02
14.0cm

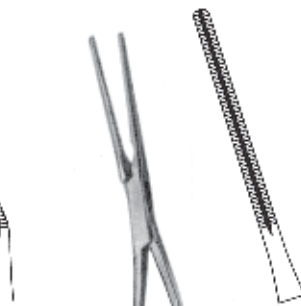

R-0500-03
14.0cm

COOLEY



R-0500-04
14.0cm

COOLEY



R-0500-05
14.0cm



R-0504-17
17.0cm

COOLEY

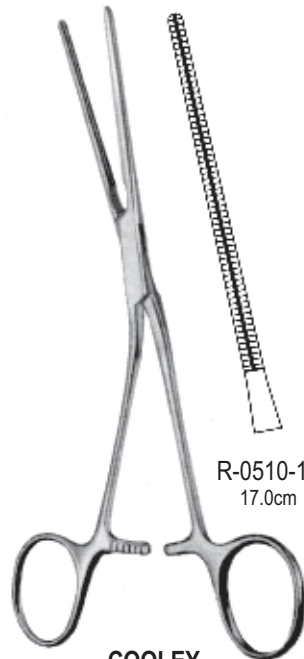

R-0510-17
17.0cm

COOLEY

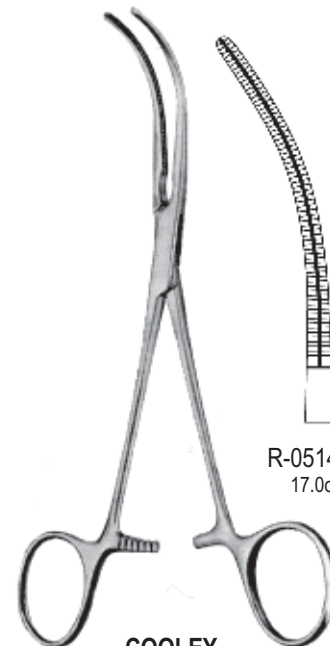

R-0514-17
17.0cm

COOLEY

CRODIOVASCULAR

ALSO AVAILABLE IN TITANIUM



COOLEY
R-0520-17 17.0cm

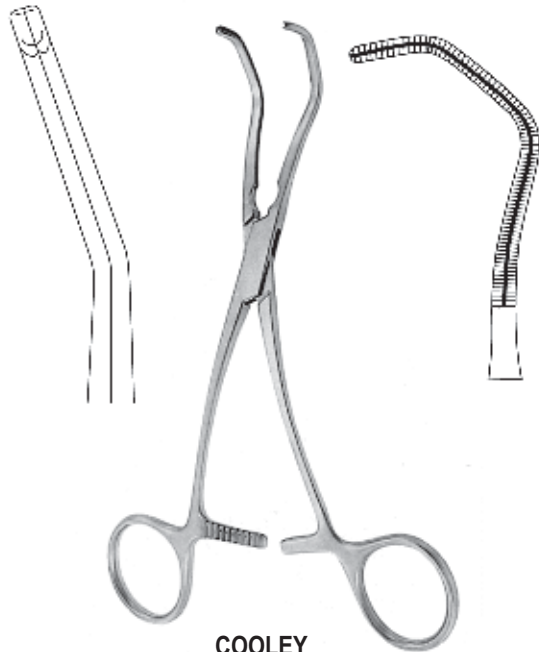

COOLEY
R-0524-16 16.0cm

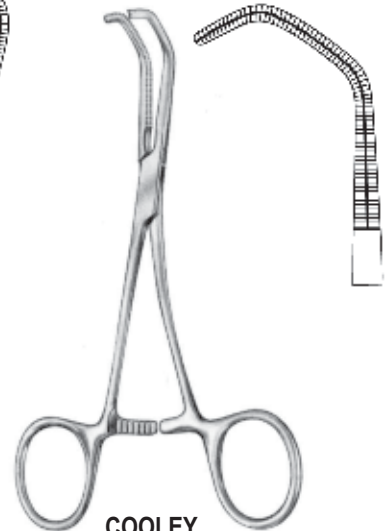

COOLEY
R-0530-14 14.0cm

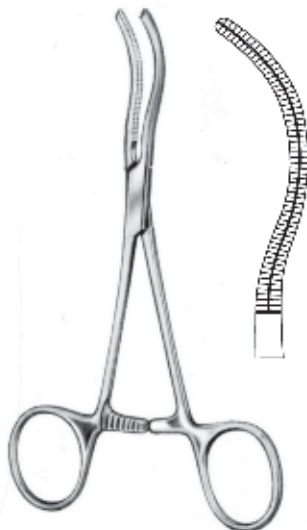

COOLEY
R-0534-14 14.0cm

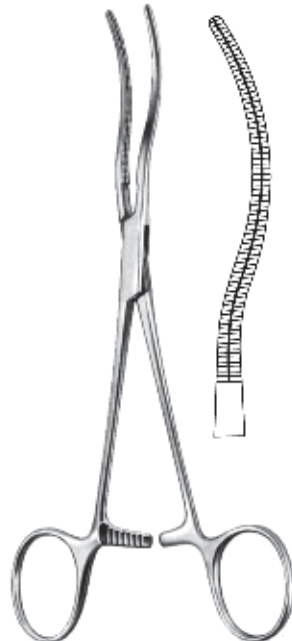

COOLEY
R-0540-17 17.0cm

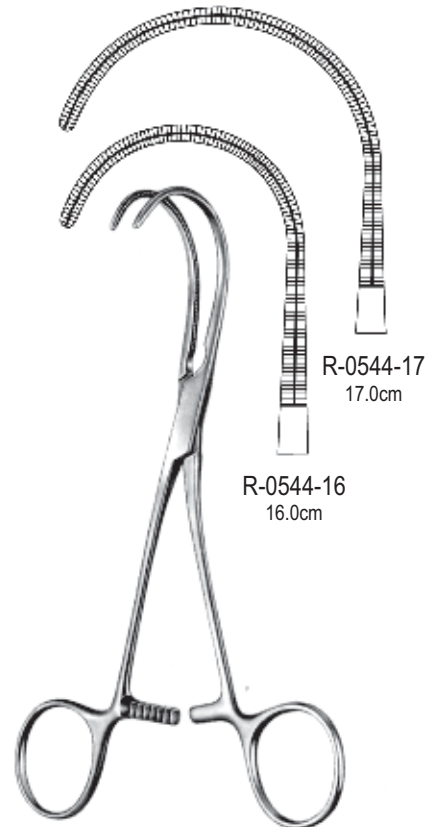

R-0544-16
16.0cm

R-0544-17
17.0cm

COOLEY

CARDIOVASCULAR

ALSO AVAILABLE IN TITANIUM



COOLEY-DERRA

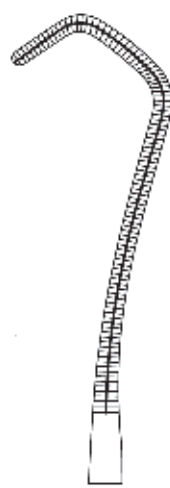

R-0550-16
16.0cm

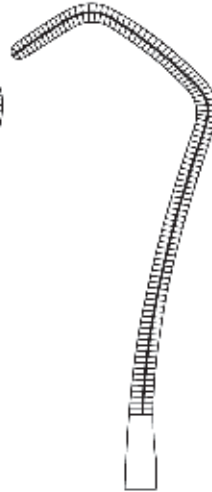

R-0550-17
17.0cm



R-0550-18
18.0cm



COOLEY

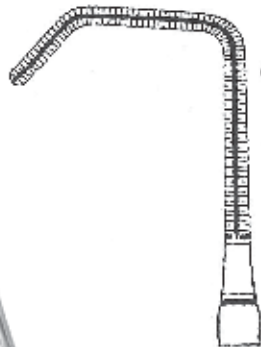

R-0560-01
16.5cm

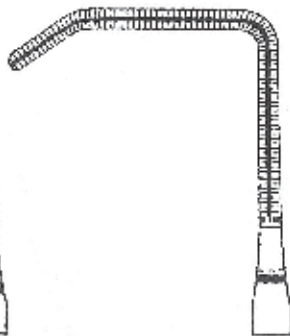

R-0560-02
16.5cm

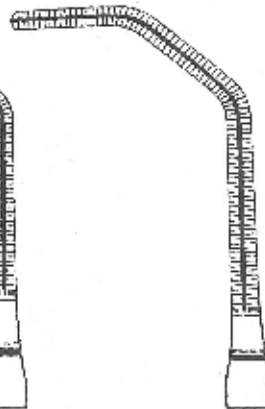

R-0560-03
17.5cm

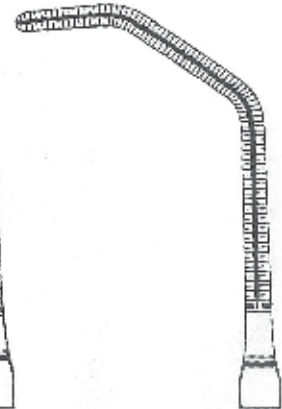

R-0560-04
17.5cm

CRODIOVASCULAR

ALSO AVAILABLE IN TITANIUM

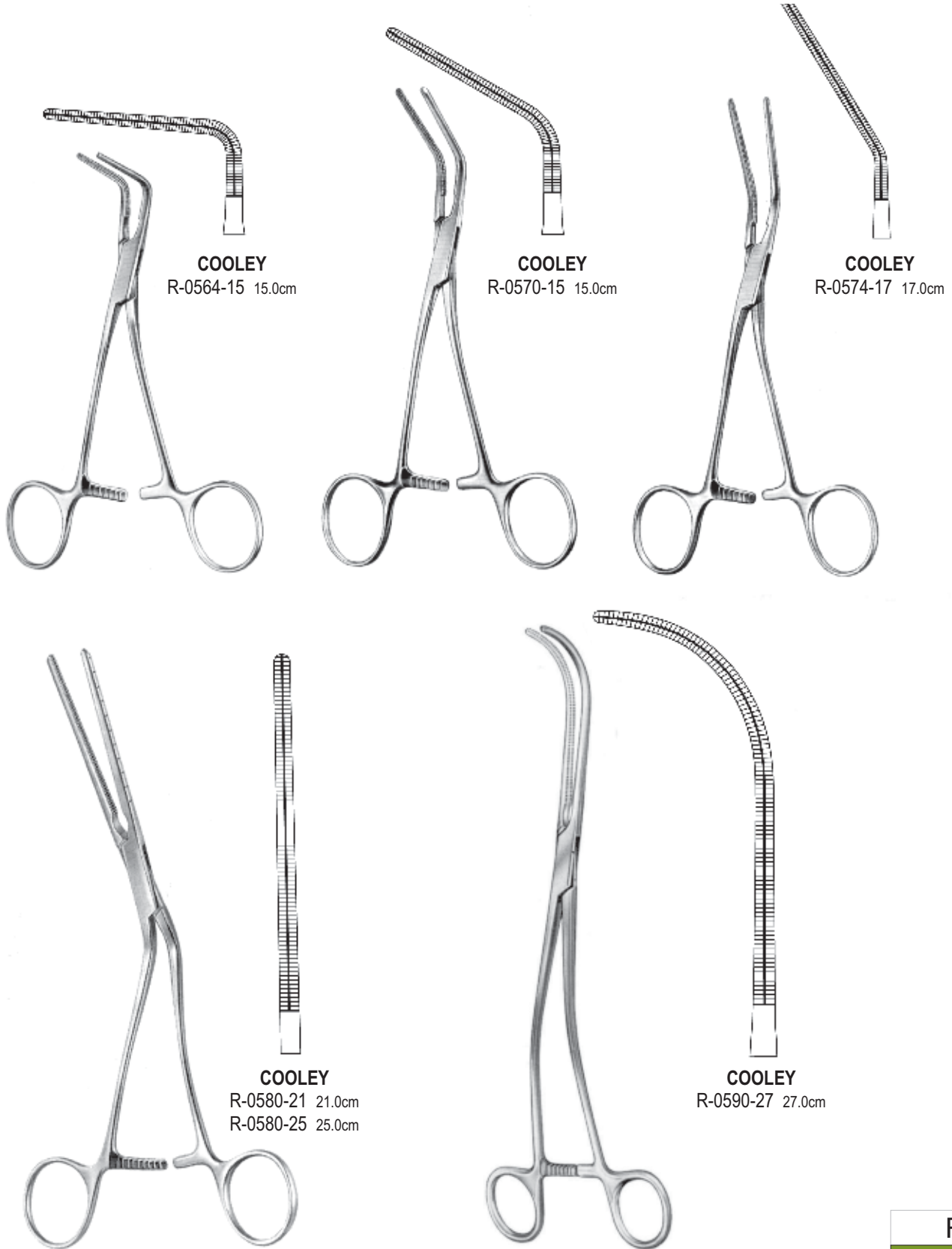

CARDIOVASCULAR

ALSO AVAILABLE IN TITANIUM

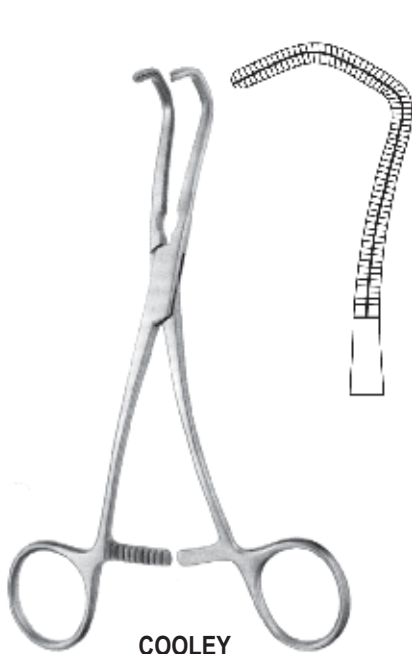

COOLEY
R-0594-17 17.0cm

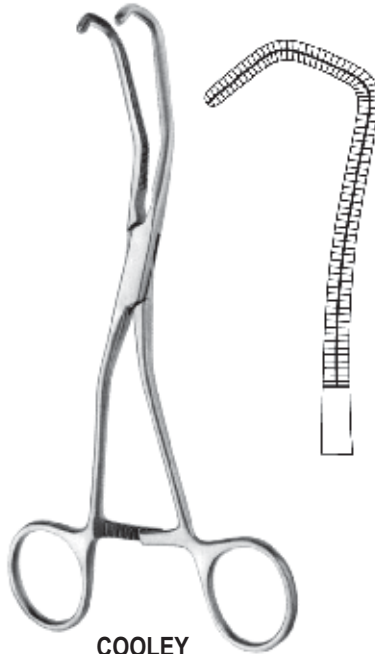

COOLEY
R-0596-17 17.0cm

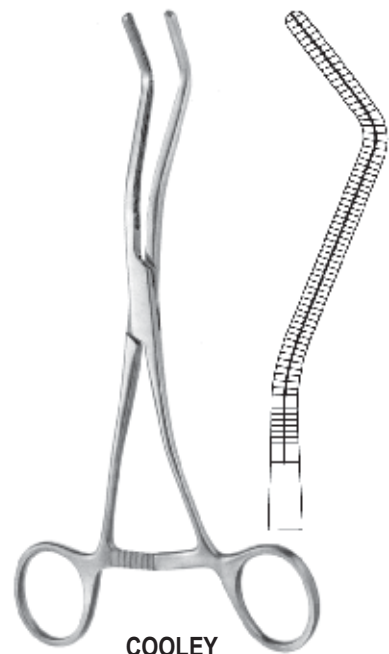

COOLEY
R-0600-18 18.0cm

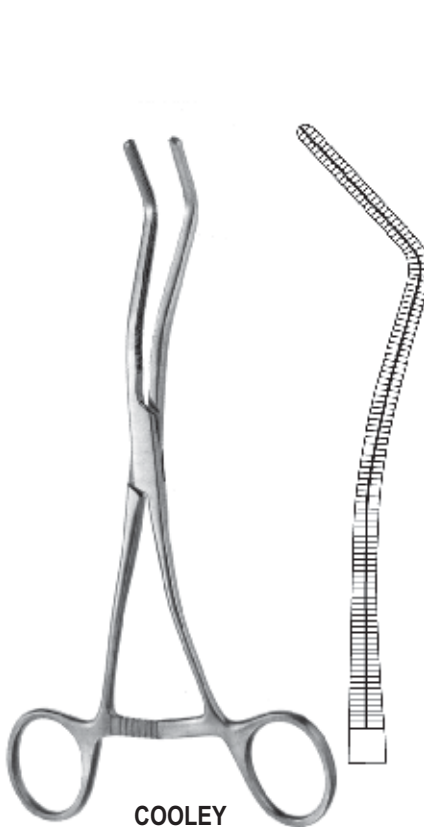

COOLEY
R-0602-19 19.0cm



COOLEY
R-0604-26 26.0cm

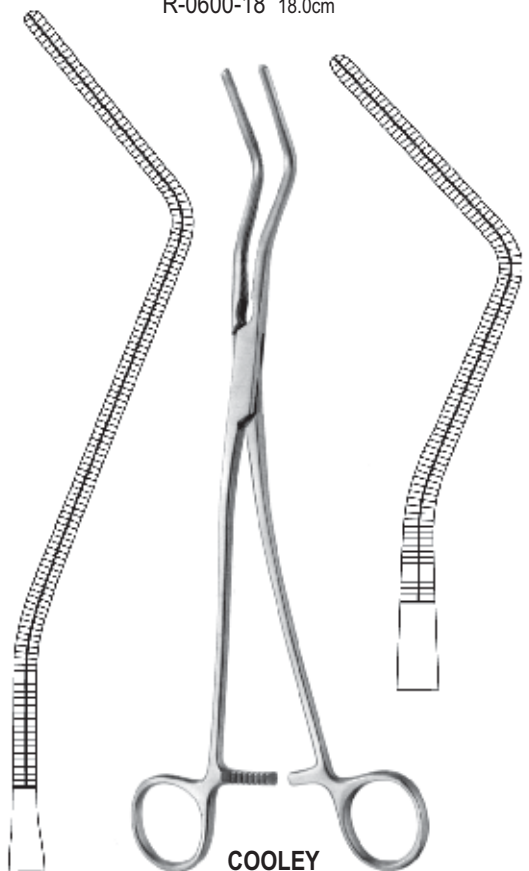

COOLEY
R-0606-27 27.0cm

CRODIOVASCULAR

ALSO AVAILABLE IN TITANIUM



R-0610-15 15.0cm

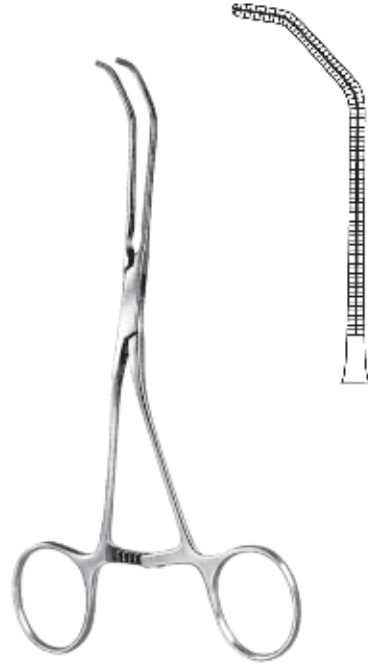

R-0614-15 15.5cm

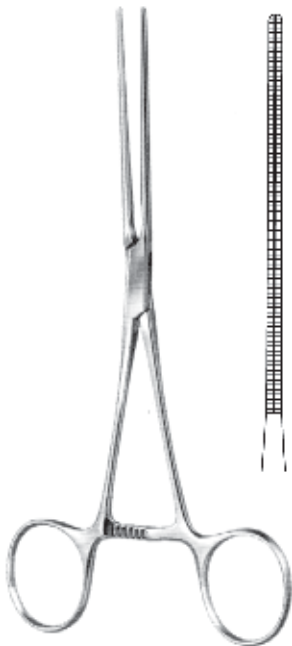

R-0620-16 16.5cm

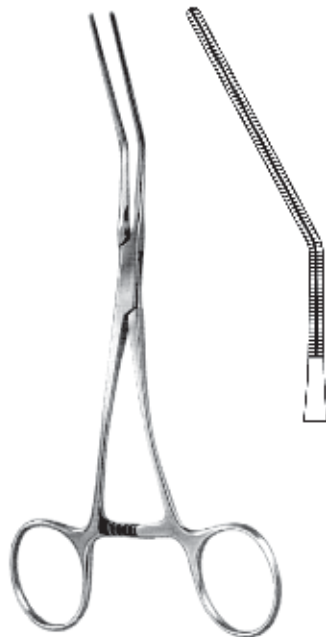

R-0622-16 16.0cm



R-0624-15 15.0cm

CARDIOVASULAR

ALSO AVAILABLE IN TITANIUM



1



2



3



4



5



6



7



8



9



- 1 R-0630-01 14.5cm
- 2 R-0630-02 14.5cm
- 3 R-0630-03 14.5cm
- 4 R-0630-04 13.5cm
- 5 R-0630-05 14.0cm
- 6 R-0630-06 13.5cm
- 7 R-0630-07 13.5cm
- 8 R-0630-08 14.0cm
- 9 R-0630-09 13.5cm

- 1 R-0632-01 14.5cm
- 2 R-0632-02 14.5cm
- 3 R-0632-03 14.5cm
- 4 R-0632-04 13.5cm
- 5 R-0632-05 14.0cm
- 6 R-0632-06 13.5cm
- 7 R-0632-07 13.5cm
- 8 R-0632-08 14.0cm
- 9 R-0632-09 13.5cm

- 1 R-0634-01 14.5cm
- 2 R-0634-02 14.5cm
- 3 R-0634-03 14.5cm
- 4 R-0634-04 13.5cm
- 5 R-0634-05 14.0cm
- 6 R-0634-06 13.5cm
- 7 R-0634-07 13.5cm
- 8 R-0634-08 14.0cm
- 9 R-0634-09 13.5cm

Neonatal and Pediatric Clamps, Delicate Pattern | EN
Neonatal-und Kinderklemmen, Extrafeine Modelle | DE
Pinzas clamps para recién nacidos y pediátricos muy delicados | ES



CRODIOVASCULAR

ALSO AVAILABLE IN TITANIUM



R-0640-01
13.0cm

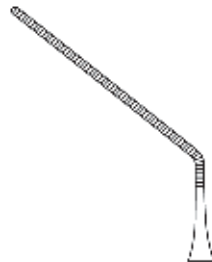

R-0640-02
13.0cm

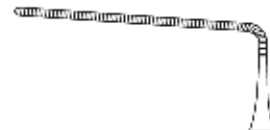

R-0640-03
11.0cm



CASTANEDA

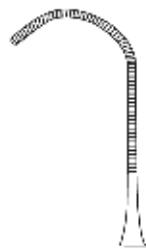

R-0642-01
12.0cm



R-0642-02
12.0cm



R-0642-03
12.0cm



R-0642-04
12.0cm

CARDIOVASCULAR

ALSO AVAILABLE IN TITANIUM



JAVID
R-0650-18 18.0cm

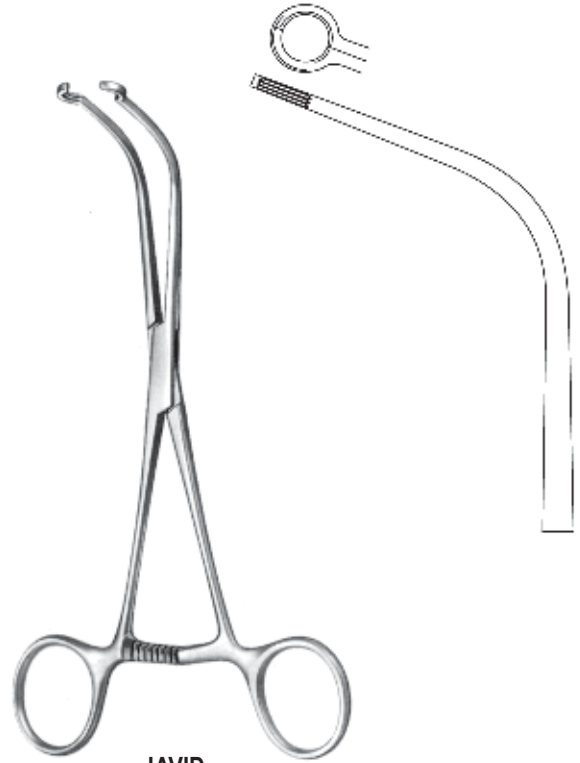

JAVID
R-0650-19 19.0cm

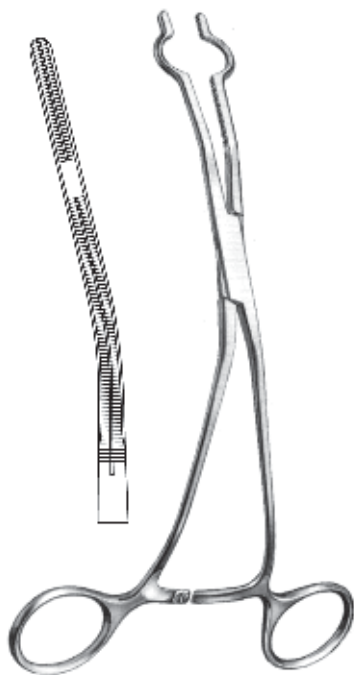

COOLEY

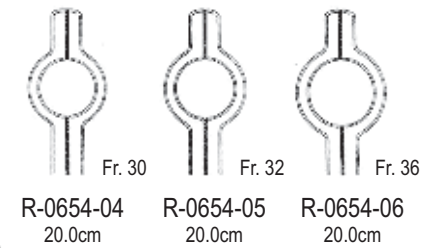
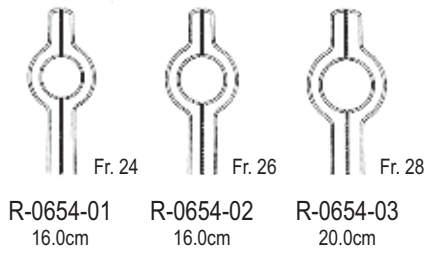

R-0660-18 18.0cm

CRODIOVASCULAR

ALSO AVAILABLE IN TITANIUM

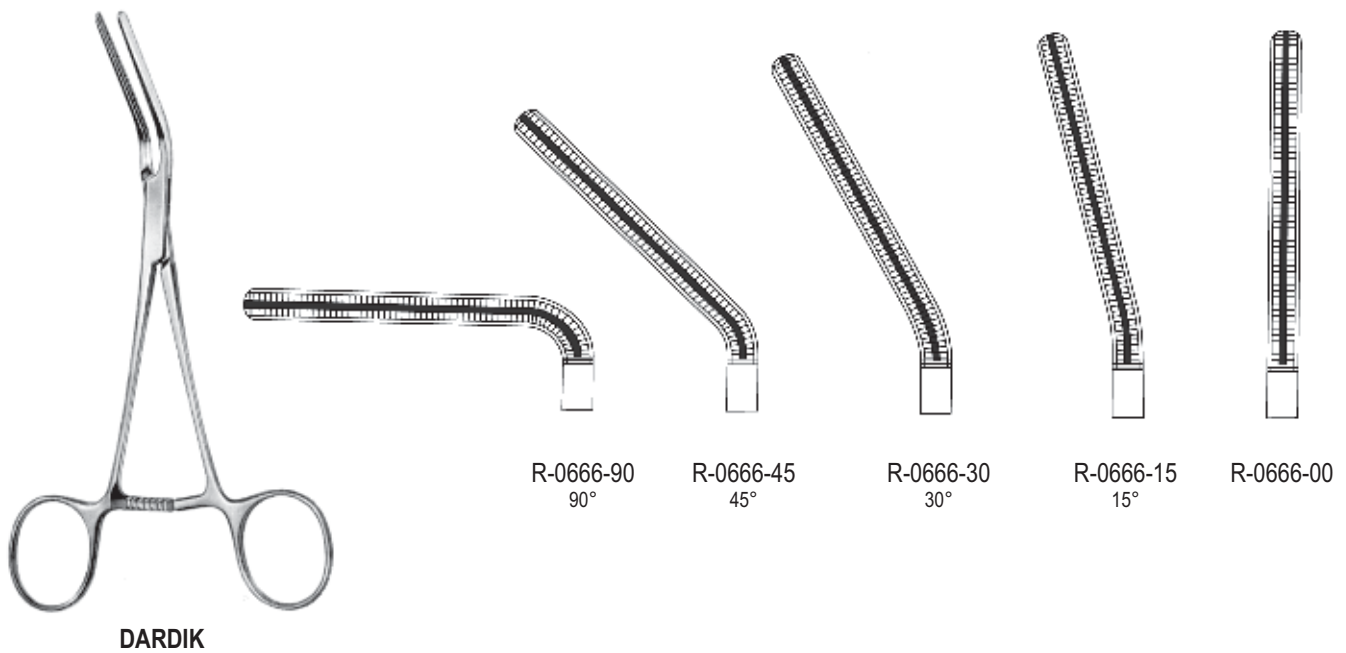
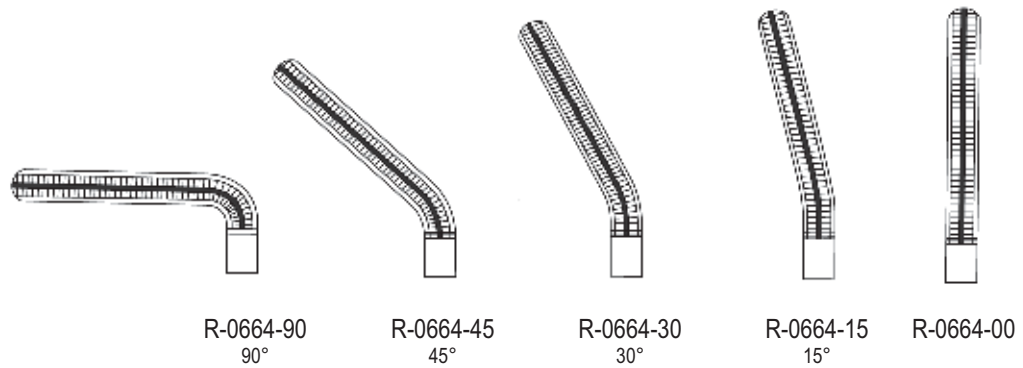

CARDIOVASCULAR

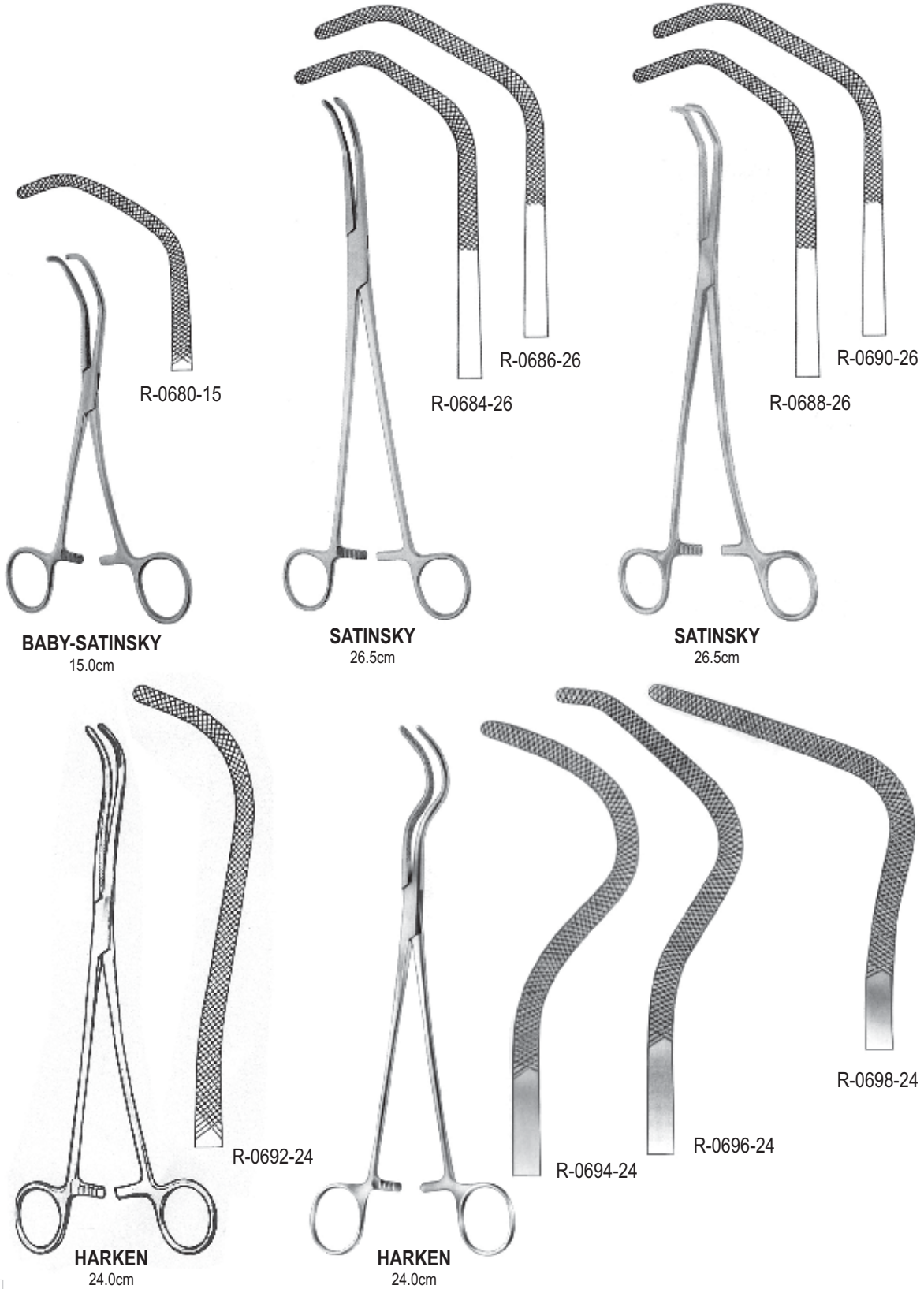

CRODIOVASCULAR



LOVELACE
R-0710-20 20.0cm

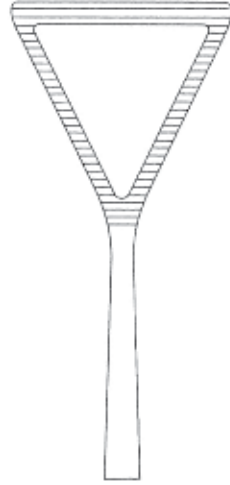

LOVELACE
R-0711-20 20.0cm



BLALOCK



14mm
R-0720-14 15.0cm

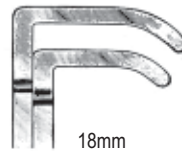

18mm
R-0722-18 20.0cm

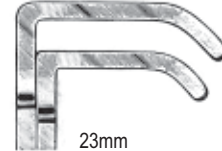

23mm
R-0722-23 20.0cm

CARDIOVASULAR

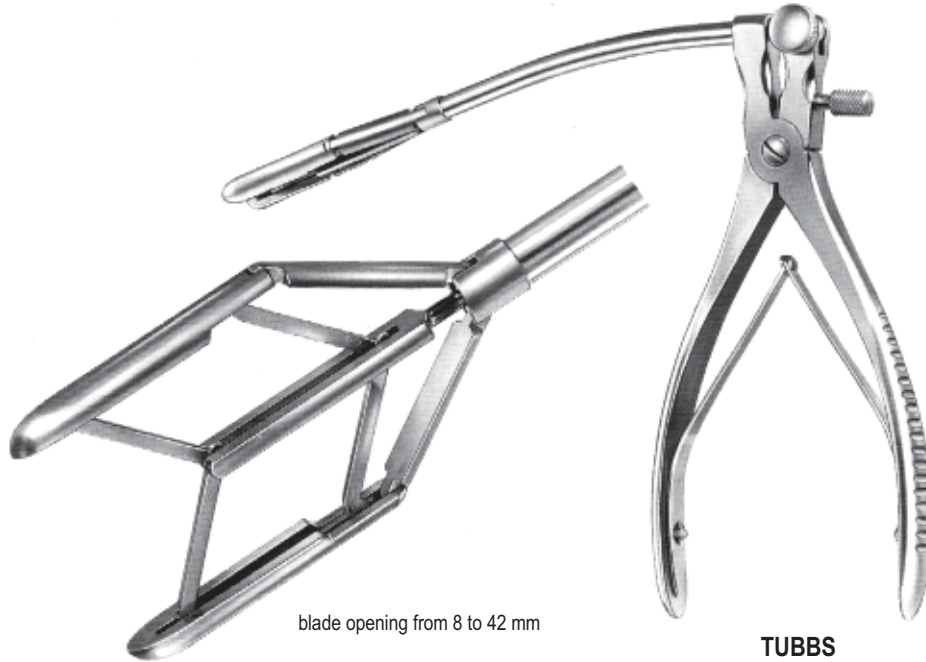

blade opening from 8 to 42 mm

TUBBS
R-0740-42

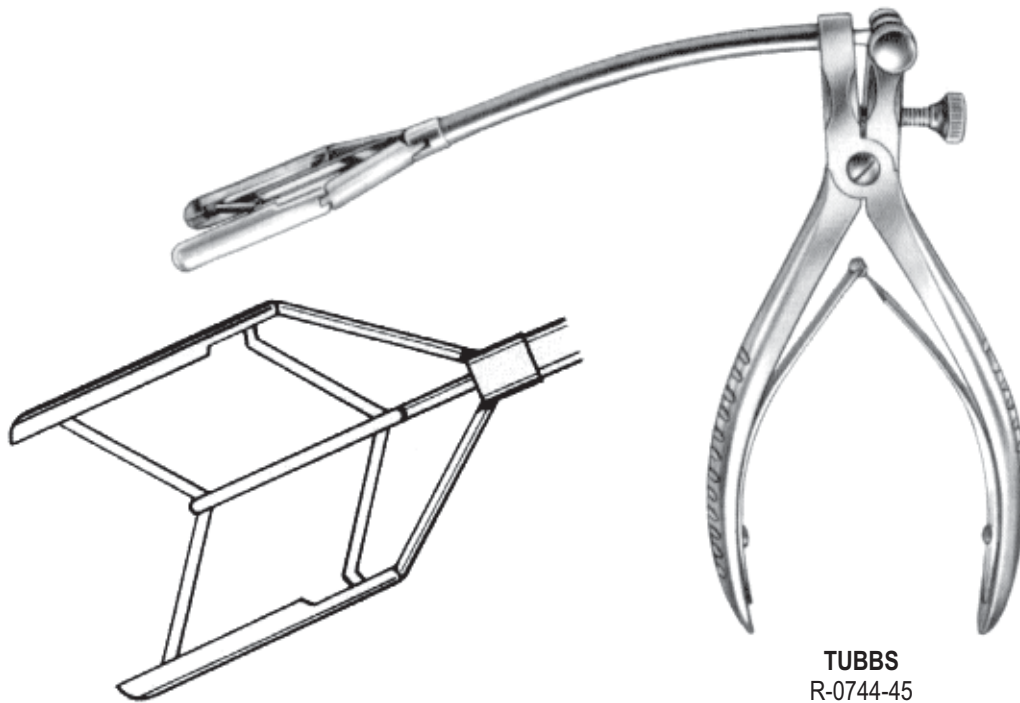

blade opening from 9 to 45 mm

TUBBS
R-0744-45

CRODIOVASCULAR

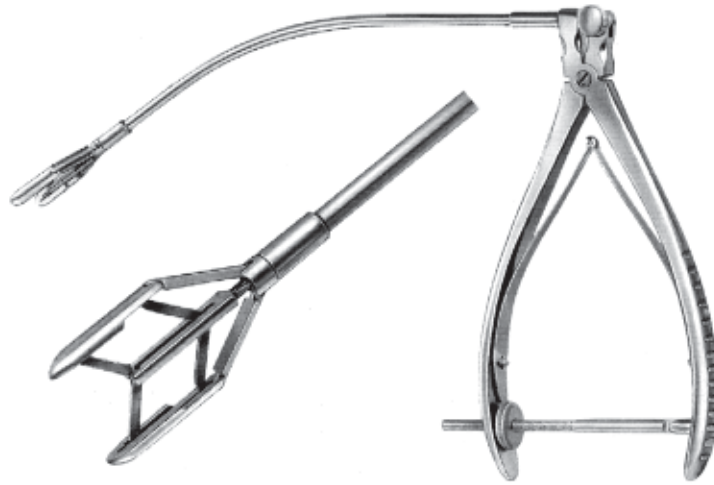

blade opening from 8 to 15 mm
blade opening from 8 to 45 mm

COOLEY
R-0750-15
R-0750-45

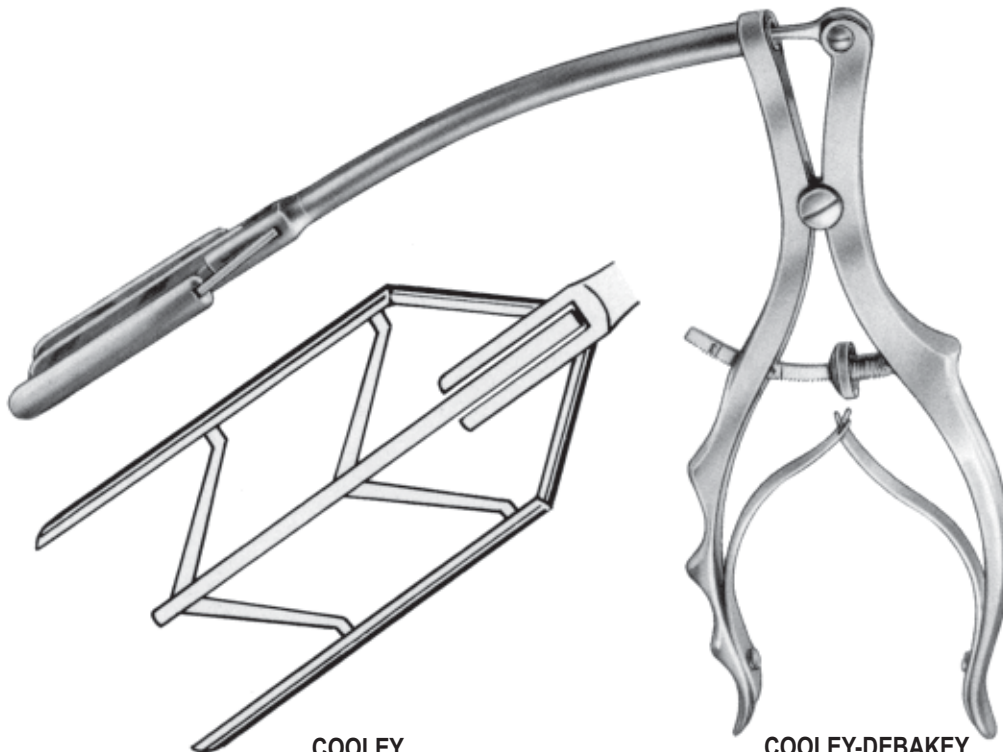

COOLEY
R-0754-40
blade opening 9 - 40mm

COOLEY-DEBAKEY
R-0756-30
blade opening 7 - 30mm

CARDIOVASULAR

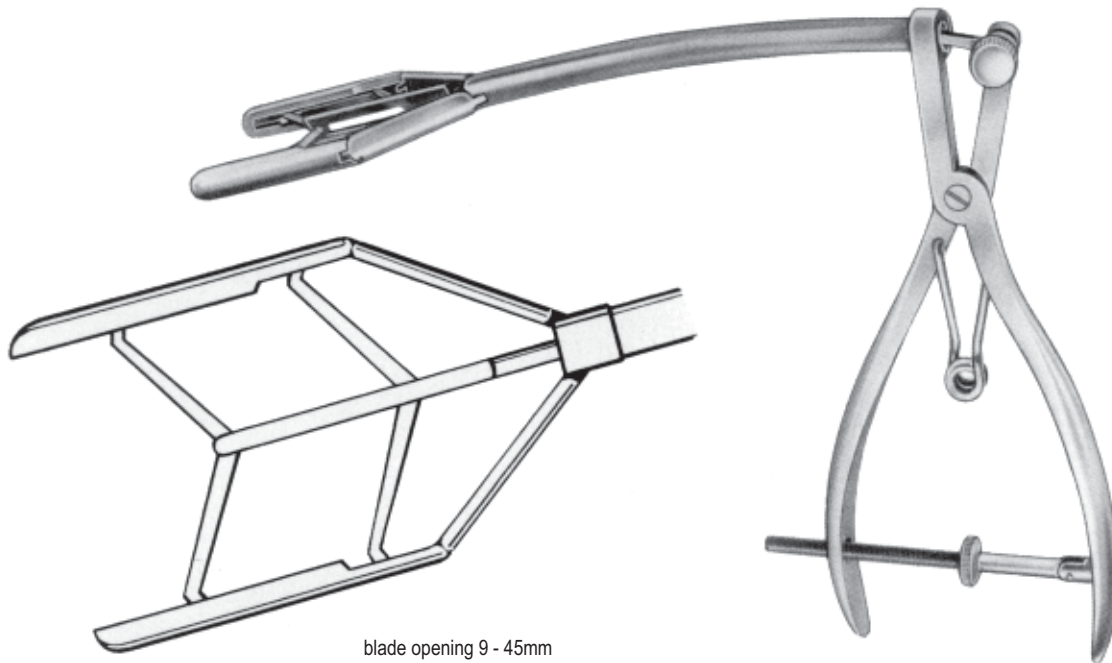

blade opening 9 - 45mm

GERBODE
R-0760-45

Mitral valve Dilators | EN
Mitral ventil dilatoren | DE
Dilatadores mitral de válvula | ES

dagno
DIAGNOSURGI

CRODIOVASCULAR



Blade opening 4 - 10mm

HETZER
R-0770-10



COOLEY blade opening
R-0776-18 5 - 18mm
R-0776-20 6 - 20mm

R-047

CARDIOVASULAR

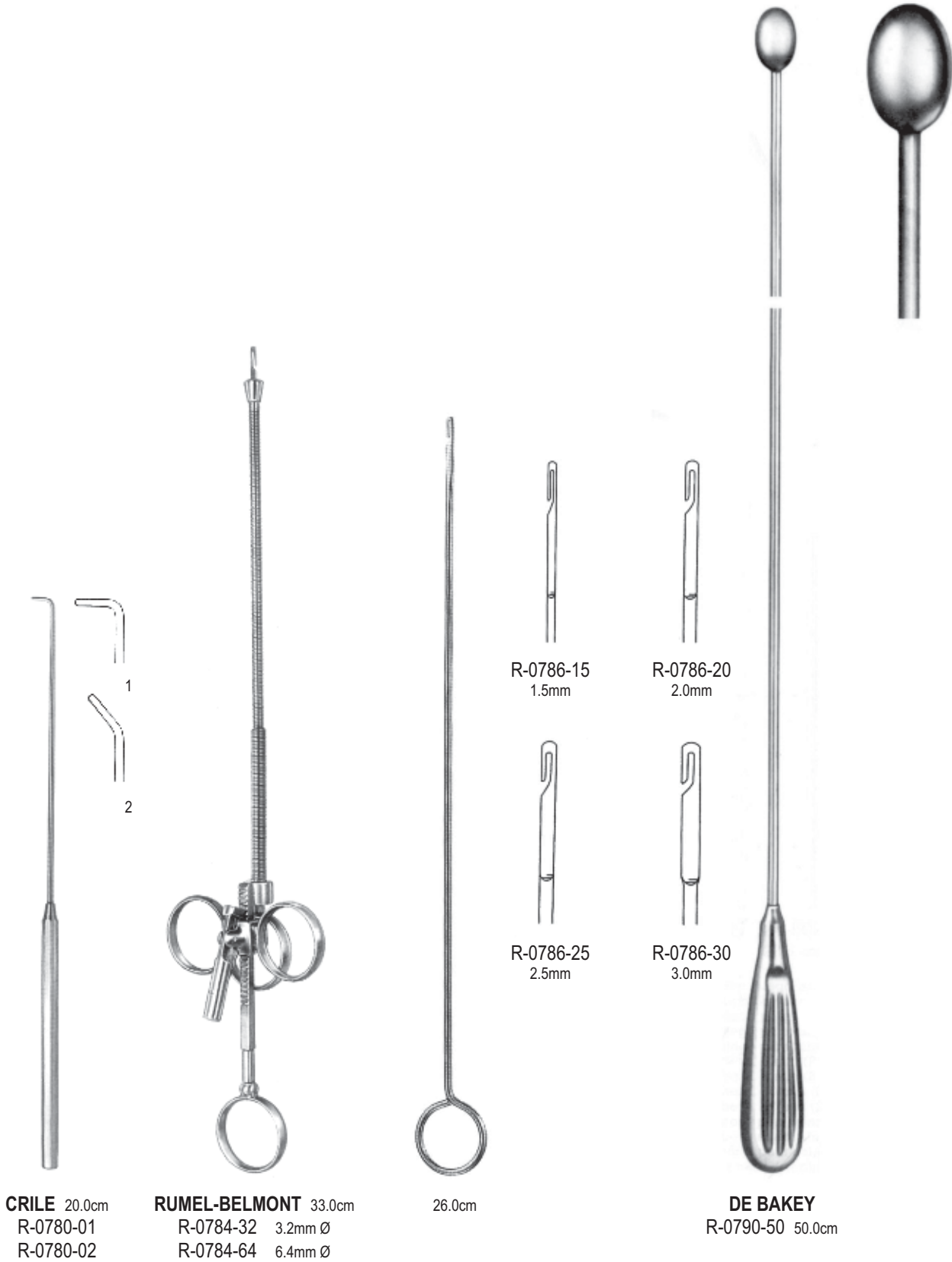

CRILE 20.0cm
 R-0780-01
 R-0780-02

RUMEL-BELMONT 33.0cm
 R-0784-32 3.2mm Ø
 R-0784-64 6.4mm Ø

26.0cm

R-0786-15
 1.5mm

R-0786-20
 2.0mm

R-0786-25
 2.5mm

R-0786-30
 3.0mm

DE BAKEY
 R-0790-50 50.0cm

CRODIOVASCULAR

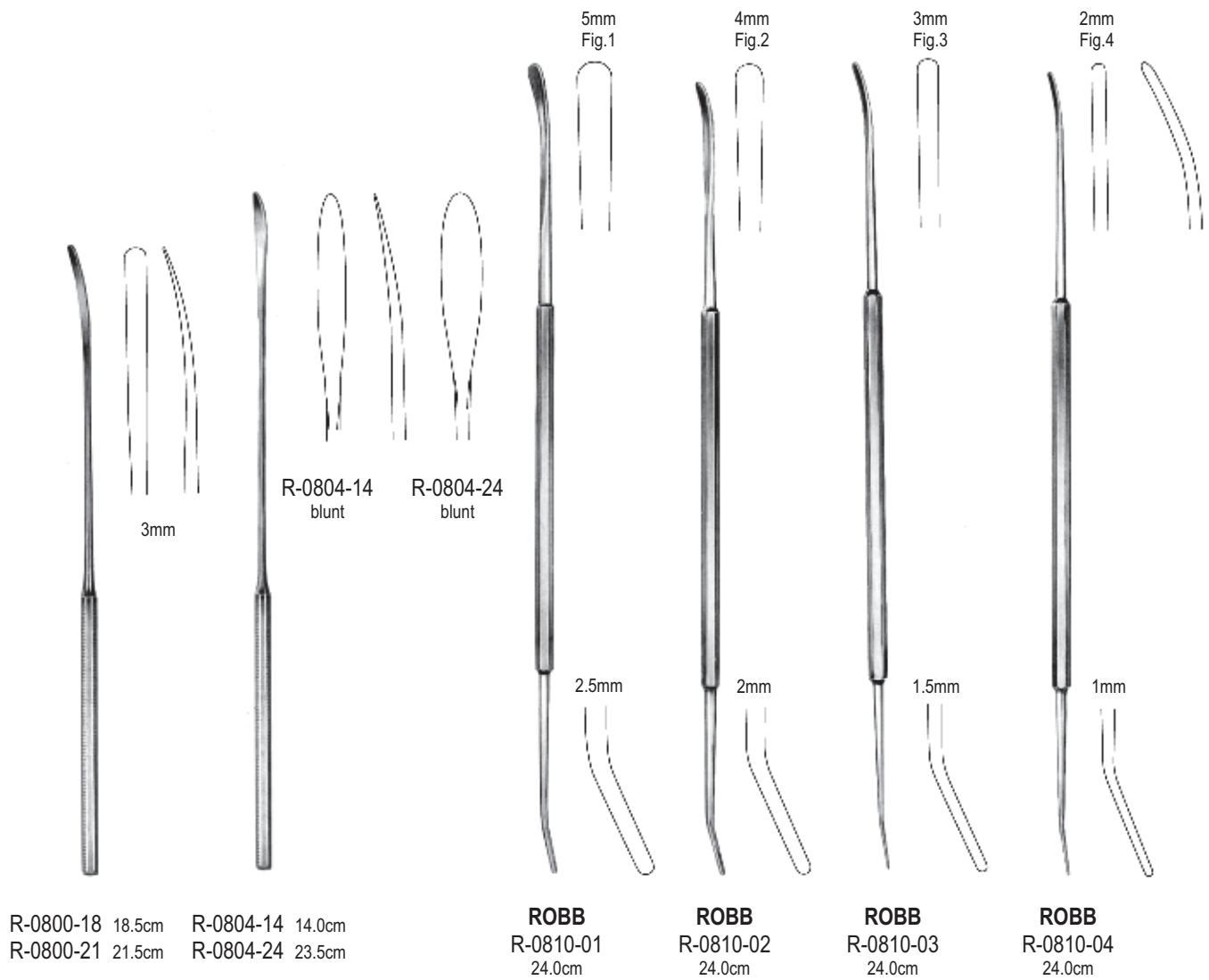

CARDIOVASULAR

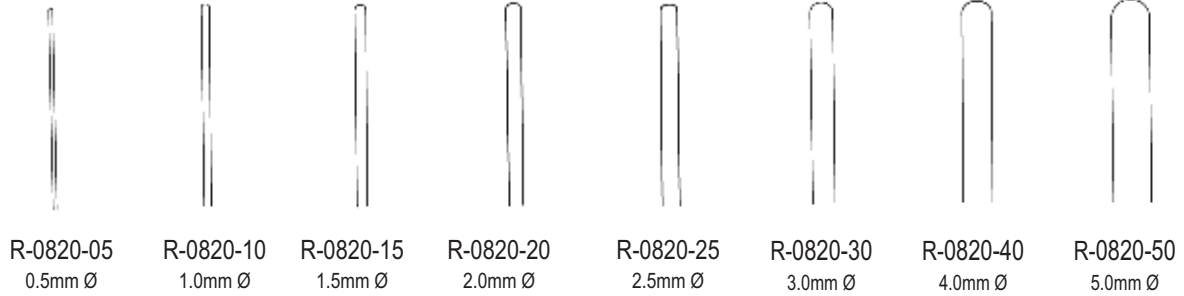

COOLEY
13.0cm

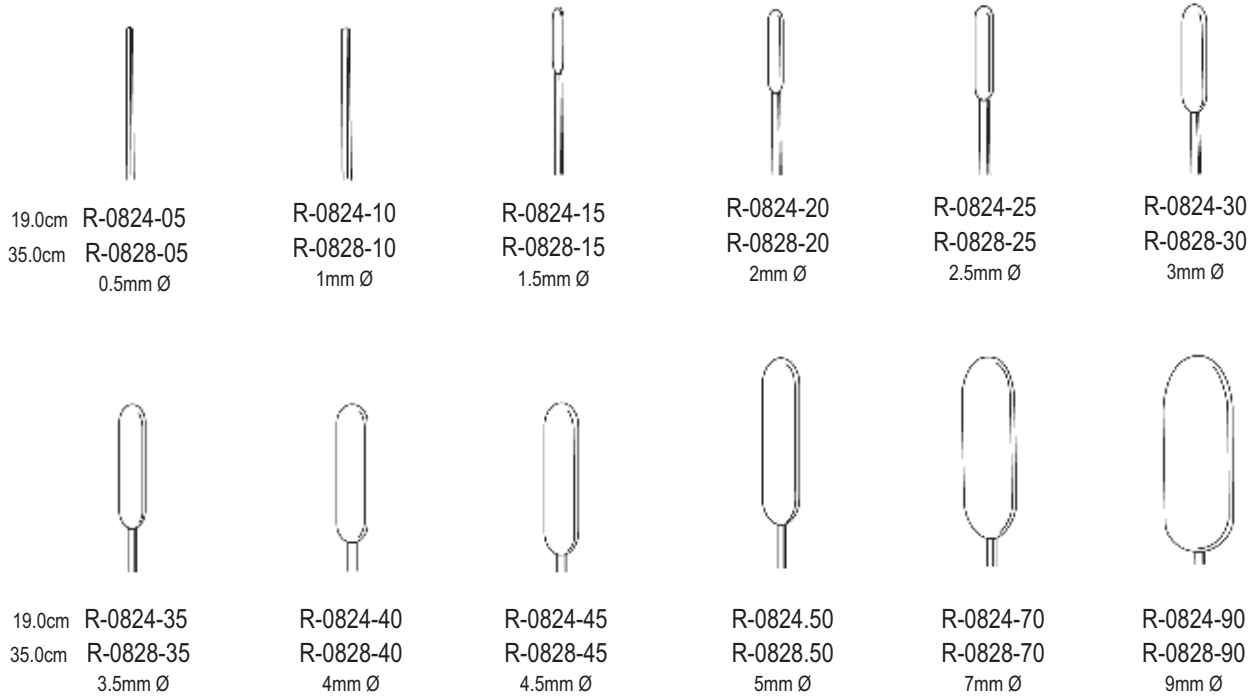

DE BAKEY