

Operating Scissors EN

Chirurgische Scheren DE

Tijeras para cirugía ES

10

TC - SCISSORS



STANDARD

10.5cm	10.5010.10	10.5011.10
11.5cm	10.5010.11	10.5011.11
13.0cm	10.5010.13	10.5011.13
14.5cm	10.5010.14	10.5011.14
15.5cm	10.5010.15	10.5011.15
16.5cm	10.5010.16	10.5011.16
18.5cm	10.5010.18	10.5011.18
20.0cm	10.5010.20	10.5011.20

STANDARD

10.5012.10	10.5013.10
10.5012.11	10.5013.11
10.5012.13	10.5013.13
10.5012.14	10.5013.14
10.5012.15	10.5013.15
10.5012.16	10.5013.16
10.5012.18	10.5013.18
10.5012.20	10.5013.20

STANDARD

10.5014.10	10.5015.10
10.5014.11	10.5015.11
10.5014.13	10.5015.13
10.5014.14	10.5015.14
10.5014.15	10.5015.15
10.5014.16	10.5015.16
10.5014.18	10.5015.18
10.5014.20	10.5015.20

10.5015.20

10-001



EN Operating Scissors

DE Chirurgische Scheren

ES Tijeras para cirugía



TC - SCISSORS



GRAZIL

10.5022.13 13.0cm 10.5023.13
10.5022.14 14.0cm 10.5023.14



GRAZIL

10.5024.13 13.0cm 10.5025.13
10.5024.14 14.0cm 10.5025.14



GRAZIL

10.5026.13 13.0cm 10.5027.13
10.5026.14 14.0cm 10.5027.14



DEAVER

10.5034.14 14.0cm 10.5035.14



DEAVER

10.5036.14 14.0cm 10.5037.14



DEAVER

10.5038.14 14.0cm 10.5039.14

10.5039.14

10-002

TC - SCISSORS



MAYO

10.5052.14	14.0cm	10.5053.14
10.5052.15	15.0cm	10.5053.15
10.5052.16	16.0cm	10.5053.16
10.5052.17	17.0cm	10.5053.17
10.5052.18	18.0cm	10.5053.18
10.5052.19	19.0cm	10.5053.19
10.5052.23	23.0cm	10.5053.23



MAYO-HARRINGTON

10.5058.22	22.5cm	10.5059.22
10.5058.28	28.0cm	10.5059.28
10.5058.30	30.0cm	10.5059.30



MAYO-STILLE

10.5064.15	15.0cm	10.5065.15
10.5064.16	16.0cm	10.5065.16
10.5064.19	19.0cm	10.5065.19
10.5064.21	21.0cm	10.5065.21



MAYO-STILLE

10.5068.15	15.0cm	10.5069.15
10.5068.17	17.0cm	10.5069.17
10.5068.21	21.0cm	10.5069.21



MAYO-NOBLE

10.5072.17	17.0cm	10.5073.17
------------	--------	------------



MIXTER

10.5100.15	15.0cm	10.5101.15
------------	--------	------------

10.5101.15

10-003



TC - SCISSORS



LOCKLIN
 10.5116.16 16,0cm



LOCKLIN
 10.5118.16 16,0cm



NEUMANN
 10.5124.12 12,0cm



WAGNER
 10.5130.12 12,0cm 10.5131.12



GOLDMAN-FOX
 10.5136.13 13,0cm 10.5137.13



IRIS
 10.5142.09 9,0cm 10.5143.09
 10.5142.10 10,5cm 10.5143.10

10.5143.10

10-004

Fine Operating Scissors, Strabismus Scissors **EN**
 Fine Chirurgische Scheren, Strabismusscheren **DE**
 Tijers finas para cirugía, estrabismo **ES**

TC - SCISSORS



IRIS
 10.5144.11 11.5cm 10.5145.11



IRIS
 10.5149.11 11.0cm



STRABISMUS
 10.5160.11 11.5cm 10.5161.11



KILNER
 10.5174.12 12.0cm
 10.5174.15 15.0cm



REYNOLDS
 10.5184.15 15.0cm 10.5185.15
 10.5184.18 18.0cm 10.5185.18



SANVENERO
 10.5190.14 14.0cm 10.5191.14

10.5191.14
10-005

EN Fine Operating Scissors, Dissecting Scissors
 DE Fine Chirurgische Scheren, Präparierscheren
 ES Tijeras Finas para Cirugía, Tijeras para preparaciones



TC - SCISSORS



JOSEPH
 10.5196.14 14.0cm 10.5197.14



LEXER-BABY
 10.5300.10 10.0cm 10.5301.10



LEXER
 10.5306.16 16.0cm 10.5307.16
 10.5306.21 21.0cm 10.5307.21



MAYO-LEXER
 10.5308.16 16.0cm 10.5309.16



LEXER-FINO
 10.5310.16 16.0cm 10.5311.16



FOMON
 10.5320.13 13.5cm

10.5320.13

10-006

TC - SCISSORS



THOREK
 10.5326.19 19.0cm



METZENBAUM-BABY
 10.5330.11 11.5cm 10.5331.11



METZENBAUM
 10.5336.14 14.0cm 10.5337.14
 10.5336.15 15.0cm 10.5337.15



METZENBAUM
 10.5340.14 14.5cm 10.5341.14

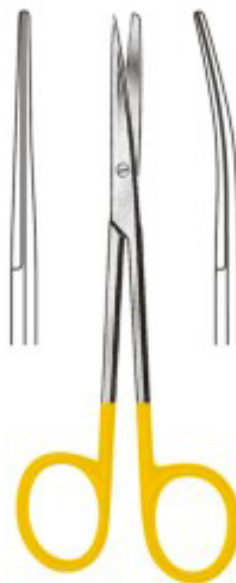

METZENBAUM
 10.5342.14 14.5cm 10.5343.14

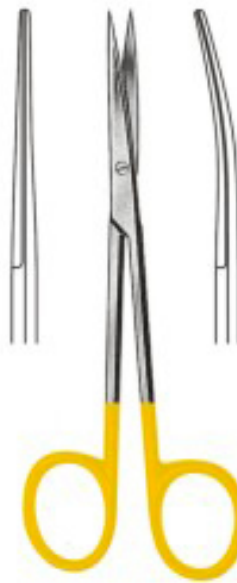

METZENBAUM
 10.5344.14 14.5cm 10.5345.14

10.5345.14

10-007



TC - SCISSORS



METZENBAUM-FINO
 10.5350.14 14.5cm 10.5351.14



METZENBAUM-FINO
 10.5352.14 14.5cm 10.5353.14



METZENBAUM-FINO
 10.5360.18 18.0cm 10.5361.18
 10.5360.20 20.0cm 10.5361.20
 10.5360.23 23.0cm 10.5361.23
 10.5360.25 25.0cm 10.5361.25
 10.5360.28 28.0cm 10.5361.28



METZENBAUM-FINO
 10.5362.18 18.0cm 10.5363.18
 10.5362.20 20.0cm 10.5363.20
 10.5362.23 23.0cm 10.5363.23
 10.5362.25 25.0cm 10.5363.25
 10.5362.28 28.0cm 10.5363.28



METZENBAUM-FINO
 10.5370.18 18.0cm
 10.5370.20 20.0cm
 10.5370.23 23.0cm



METZENBAUM-FINO
 10.5374.18 18.0cm
 10.5374.20 20.0cm
 10.5374.23 23.0cm

10.5374.23

10-008

TC - SCISSORS



METZENBAUM - NELSON
 10.5380.18 18.0cm 10.5381.18
 10.5380.20 20.0cm 10.5381.20
 10.5380.23 23.0cm 10.5381.23
 10.5380.25 25.0cm 10.5381.25
 10.5380.28 28.0cm 10.5381.28
 10.5380.30 30.0cm 10.5381.30

METZENBAUM - NELSON
 10.5382.18 18.0cm 10.5383.18
 10.5382.20 20.0cm 10.5383.20
 10.5382.23 23.0cm 10.5383.23
 10.5382.25 25.0cm 10.5383.25
 10.5382.28 28.0cm 10.5383.28
 10.5382.30 30.0cm 10.5383.30

METZENBAUM - NELSON
 10.5384.18 18.0cm 10.5385.18
 10.5384.20 20.0cm 10.5385.20
 10.5384.23 23.0cm 10.5385.23
 10.5384.25 25.0cm 10.5385.25
 10.5384.28 28.0cm 10.5385.28
 10.5384.30 30.0cm 10.5385.30

10.5385.30

10-009

TC - SCISSORS



METZENBAUM-THOREK
 10.5388.20 20.0cm
 10.5388.23 23.0cm
 10.5388.28 28.0cm



METZENBAUM-S
 10.5392.20 20.0cm
 10.5392.23 23.0cm
 10.5392.25 25.0cm
 10.5392.28 28.0cm



FOMON
 10.5400.15 15.0cm



COTTLE
 10.5406.16 16.0cm



HEYMANN
 10.5410.18 18.0cm

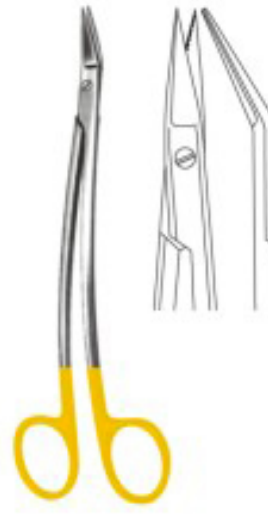

DEAN
 10.5416.17 17.0cm

10.5416.17

10-010

Tonsil and Nasal Scissors, Thorax and Vascular Scissors **EN**
Tonsillen-und-Nasenscheren, Thoraxscheren, Gefabscheren **DE**
Tijeras nasales y para Amigdalas, Tijeras Tracicas y Vasculares **ES**

10

TC - SCISSORS



BOETTCHER
10.5420.18 18.0cm



PRINCE
10.5424.17 17.0cm



GOOD
10.5428.19 19.0cm



KLINKENBERGH-LOTH
10.5500.23 23.0cm



SATINSKY
10.5504.24 24.5cm



CRAFOORD
10.5510.30 30.0cm

10.5510.30

10-011



TC - SCISSORS



DE BAKEY
 10.5514.15 15.5cm



DE BAKEY
 10.5516.15 15.5cm



FAVALORO
 10.5520.15 15.0cm



PARAMETRIUM
 10.5520.22 22.5cm
 10.5520.23 23.0cm



MC INDOE
 10.5524.19 19.0cm



POTTS DE MARTEL
 10.5530.21 21.0cm
 10.5530.24 24.0cm

10.5530.24

10-012

TC - SCISSORS

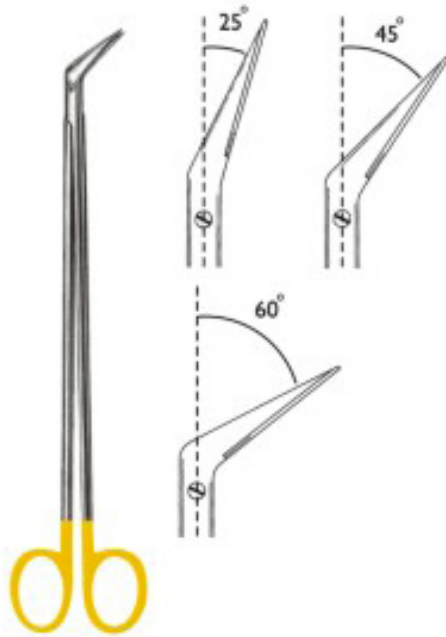

DE BAKEY

	25°	45°	60°
16.0cm	10.5534.16	10.5536.16	10.5538.16
23.0cm	10.5534.23	10.5536.23	10.5538.23
28.0cm	10.5534.28	10.5536.28	10.5538.28

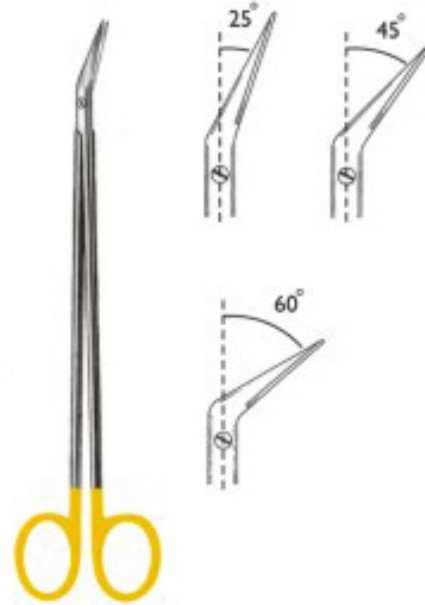

POTTS - SMITH

	19.0cm
10.5540.25	25°
10.5540.45	45°
10.5540.60	60°



TOENNIS

10.5600.18	18.0cm	10.5601.18
------------	--------	------------



TOENNIS-ADSON

10.5606.17	17.5cm
------------	--------

10.5606.17

10-013

EN Abdominal, Cephalotmy and Fistula Scissors
 DE Bauchdeckdecken-Kephalotom und Fistel-Scheren
 ES Tijeras abdominales, para decepition y para fistulas



TC - SCISSORS



KELLY



10.5630.16
18.0cm



10.5630.18
18.0cm



10.5631.16
18.0cm



10.5631.18
18.0cm



DUBOIS

10.5641.17
10.5636.27 27.0cm 10.5637.27



DOYEN

10.5640.17 17.0cm 10.5641.17

10.5641.17

10-014

TC - SCISSORS



LLOYD-DAVIES (GOLIGHER'S)
 10.5646.25 25.5cm



SIEBOLD
 10.5650.24 24.0cm



WERTHEIM
 10.5654.14 14.5cm
 10.5654.19 19.5cm
 10.5654.22 22.5cm



SIMS
 10.5660.20 20.0cm 10.5661.20
 10.5660.23 23.0cm 10.5661.23

10.5661.23

10-015

EN Umbilical, Episiotomy And Enterotomy Scissors, Ligature Scissors
 DE Nabelschnur-Episiotomie-und Darmscheren, Ligaturscheren
 ES Tijeras umbilicales, p/episiotmia y p/enterotomes, Tijeras para ligaduras



TC - SCISSORS



BUSCH
10.5670.16 16.0cm



BUSCH
10.5672.16 16.0cm



UNIVERSAL
10.5808.12 12.0cm



BEEBEE



10.5810.10



(sharp)
10.0cm



10.5811.10



10.5812.10



(blunt)
10.0cm



10.5813.10



10.5814.12



(saw edge)
12.0cm



10.5815.12

10.5815.12

10-016

Ligature Scissors EN

Ligaturscheren DE

Tijeras para ligaduras ES

10

TC - SCISSORS

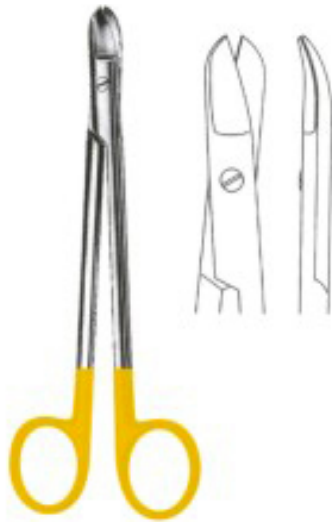

SMITH

10.5817.16 16.0cm



LISTER

24.5010.09 9.0cm
24.5010.11 11.0cm
24.5010.14 14.0cm
24.5010.16 16.0cm
24.5010.18 18.0cm
24.5010.20 20.0cm



BRUNS

24.5040.24 24.0cm



GREGORY

40.5501.14 14.0cm



KAYE

40.5511.15 15.0cm
40.5511.18 18.0cm

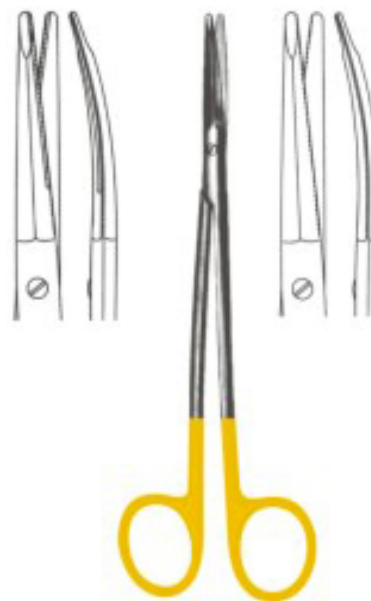

STELLA-S

40.5521.18 18.0cm

10.5521.18

10-017

- EN Face-Lift Scissors, Dissecting Scissors
- DE Verschönerung-Scheren, Präparierscheren
- ES Tijeras de la cirugía estética, Tijeras para preparaciones

dagno
DIAGNOSURGI

TC - SCISSORS



GORNEY
40.5531.18 18.0cm

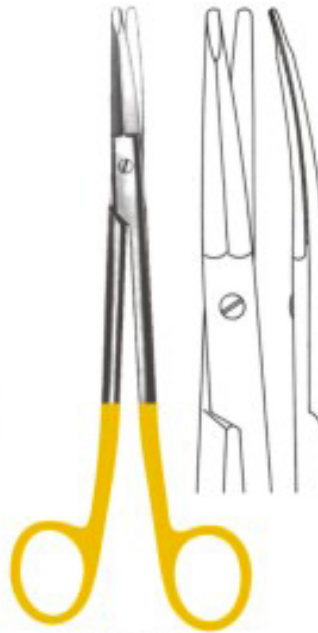

FREEMAN-KAYE
40.5541.18 18.0cm

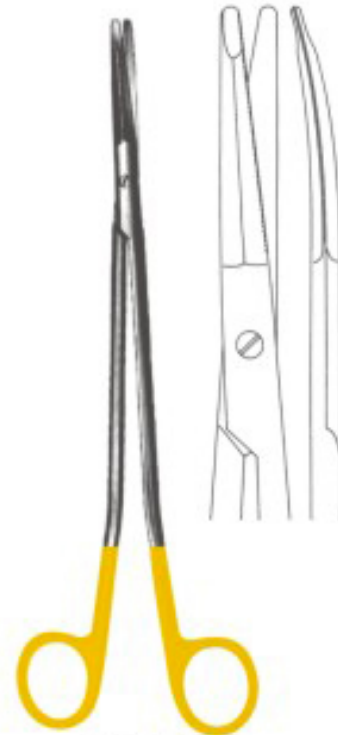

FREEMAN
40.5551.23 23.0cm



TESSIER
49.5500.14 14.0cm



TESSIER
49.5510.16 16.0cm

10.5510.16

10-018



Operating Scissors EN

Chirurgische Scheren DE

Tijeras para cirugía ES

09

TC SUPER CUT - SCISSORS



STANDARD

10.5cm	09.5010.10	09.5011.10
11.5cm	09.5010.11	09.5011.11
13.0cm	09.5010.13	09.5011.13
14.5cm	09.5010.14	09.5011.14
15.5cm	09.5010.15	09.5011.15
16.5cm	09.5010.16	09.5011.16
18.5cm	09.5010.18	09.5011.18
20.0cm	09.5010.20	09.5011.20

STANDARD

09.5012.10	09.5013.10
09.5012.11	09.5013.11
09.5012.13	09.5013.13
09.5012.14	09.5013.14
09.5012.15	09.5013.15
09.5012.16	09.5013.16
09.5012.18	09.5013.18
09.5012.20	09.5013.20

STANDARD

09.5014.10	09.5015.10
09.5014.11	09.5015.11
09.5014.13	09.5015.13
09.5014.14	09.5015.14
09.5014.15	09.5015.15
09.5014.16	09.5015.16
09.5014.18	09.5015.18
09.5014.20	09.5015.20

09.5015.20

09-019

09

EN Operating Scissors
DE Chirurgische Scheren
ES Tijeras para cirugía



TC SUPER CUT - SCISSORS



DEAVER

09.5034.14 14.0cm 09.5035.14



DEAVER

09.5036.14 14.0cm 09.5037.14



DEAVER

09.5038.14 14.0cm 09.5039.14



MAYO

09.5052.14 14.0cm 09.5053.14
09.5052.15 15.0cm 09.5053.15
09.5052.16 16.0cm 09.5053.16
09.5052.17 17.0cm 09.5053.17
09.5052.18 18.0cm 09.5053.18
09.5052.19 19.0cm 09.5053.19
09.5052.23 23.0cm 09.5053.23



MAYO-HARRINGTON

09.5058.22 22.5cm 09.5059.22
09.5058.28 28.0cm 09.5059.28
09.5058.30 30.0cm 09.5059.30



MAYO-STILLE

09.5064.15 15.0cm 09.5065.15
09.5064.16 16.0cm 09.5065.16
09.5064.19 19.0cm 09.5065.19
09.5064.21 21.0cm 09.5065.21

09.5065.21

09-020



Operating Scissors EN

Chirurgische Scheren DE

Tijeras para cirugía ES

09

TC SUPER CUT - SCISSORS



MAYO-STILLE

09.5068.15 15.0cm 09.5069.15
09.5068.17 17.0cm 09.5069.17
09.5068.21 21.0cm 09.5069.21



MAYO-NOBLE

09.5072.17 17.0cm 09.5073.17



IRIS

09.5142.09 9.0cm 09.5143.09
09.5142.10 10.5cm 09.5143.10



IRIS

09.5144.11 11.5cm 09.5145.11



IRIS

09.5149.11 11.0cm



STRABISMUS

09.5160.11 11.5cm 09.5161.11

09.5161.11

09-021

09

EN Fine Operating Scissors, Strabismus Scissors
DE Fine Chirurgische Scheren, Strabismusscheren
ES Tijers finas para cirugía, estrabismo



TC SUPER CUT - SCISSORS



KILNER

09.5174.12 12.0cm
09.5174.15 15.0cm



REYNOLDS

09.5184.15 15.0cm 09.5185.15
09.5184.18 18.0cm 09.5185.18



SANVENERO

09.5190.14 14.0cm 09.5191.14



JOSEPH

09.5196.14 14.0cm 09.5197.14



LEXER-BABY

09.5300.10 10.0cm 09.5301.10



LEXER

09.5306.16 16.0cm 09.5307.16
09.5306.21 21.0cm 09.5307.21

09.5307.21

09-022





Fine Operating Scissors, Dissecting Scissors **EN**
 Fine Chirurgische Scheren, Präparierscheren **DE**
 Tijeras Finas para Cirugía, Tijeras para preparaciones **ES**

09

TC SUPER CUT - SCISSORS



MAYO-LEXER

09.5308.16 16.0cm 09.5309.16



LEXER-FINO

09.5310.16 16.0cm 09.5311.16



FOMON

09.5320.13 13.5cm



METZENBAUM

09.5336.14 14.0cm 09.5337.14
 09.5336.15 15.0cm 09.5337.15



METZENBAUM-FINO

09.5350.14 14.5cm 09.5351.14
 09.5350.18 18.0cm 09.5351.18
 09.5350.20 20.0cm 09.5351.20
 09.5350.23 23.0cm 09.5351.23



METZENBAUM-FINO

09.5352.14 14.5cm 09.5353.14
 09.5352.18 18.0cm 09.5353.18
 09.5352.20 20.0cm 09.5353.20
 09.5352.23 23.0cm 09.5353.23

09.5353.23

09-023



TC SUPER CUT - SCISSORS



METZENBAUM-FINO

09.5360.18 18.0cm 09.5361.18
 09.5360.20 20.0cm 09.5361.20
 09.5360.23 23.0cm 09.5361.23



METZENBAUM-FINO

09.5362.18 18.0cm 09.5363.18
 09.5362.20 20.0cm 09.5363.20
 09.5362.23 23.0cm 09.5363.23



METZENBAUM-FINO

09.5370.18 18.0cm
 09.5370.20 20.0cm
 09.5370.23 23.0cm

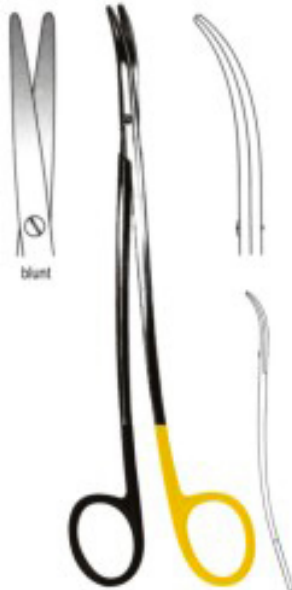

METZENBAUM-FINO

09.5374.18 18.0cm
 09.5374.20 20.0cm
 09.5374.23 23.0cm



METZENBAUM - NELSON

09.5380.18 18.0cm 09.5381.18
 09.5380.20 20.0cm 09.5381.20
 09.5380.23 23.0cm 09.5381.23
 09.5380.25 25.0cm 09.5381.25
 09.5380.28 28.0cm 09.5381.28
 09.5380.30 30.0cm 09.5381.30



METZENBAUM - NELSON

09.5382.18 18.0cm 09.5383.18
 09.5382.20 20.0cm 09.5383.20
 09.5382.23 23.0cm 09.5383.23
 09.5382.25 25.0cm 09.5383.25
 09.5382.28 28.0cm 09.5383.28
 09.5382.30 30.0cm 09.5383.30



Dissecting Scissors, Vascular Scissors **EN**
 Präparierscheren, Gefäßscheren **DE**
 Tijeras para Preparaciones, Tijeras vasculares **ES**

09

TC SUPER CUT - SCISSORS



METZENBAUM - NELSON
 09.5384.18 18.0cm 09.5385.18
 09.5384.20 20.0cm 09.5385.20
 09.5384.23 23.0cm 09.5385.23
 09.5384.25 25.0cm 09.5385.25
 09.5384.28 28.0cm 09.5385.28
 09.5384.30 30.0cm 09.5385.30



METZENBAUM-THOREK
 09.5388.20 20.0cm
 09.5388.23 23.0cm
 09.5388.28 28.0cm



METZENBAUM-S
 09.5392.20 20.0cm
 09.5392.23 23.0cm
 09.5392.25 25.0cm
 09.5392.28 28.0cm

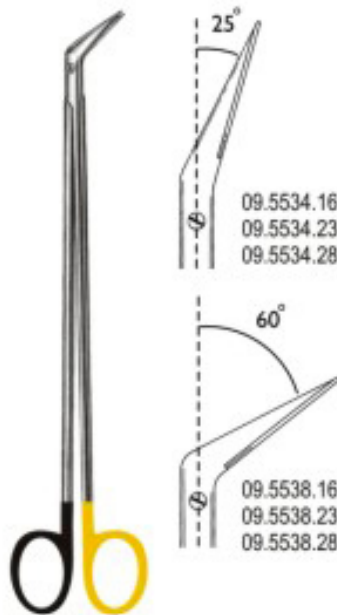

DE BAKEY
 16.0cm, 23.0cm, 28.0cm

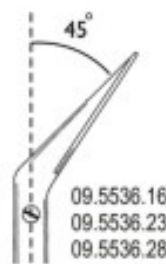

09.5536.16
 09.5536.23
 09.5536.28



09.5540.25



09.5540.45

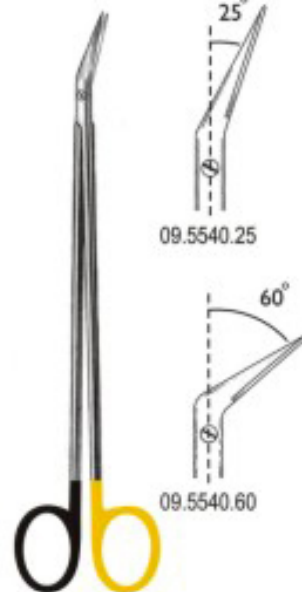

POTTS - SMITH
 19.0cm

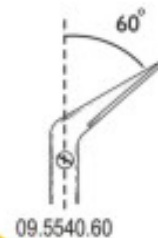

09.5540.60

09.5540.60

09-025

09

EN Gynecological & Rectal Scissors
DE Gynakologische und mastdarm Scheren
ES Tijeras para ginecologia rectales



TC SUPER CUT - SCISSORS



LLOYD-DAVIES (GOLIGHER'S)
09.5646.25 25.5cm



SIEBOLD
09.5650.24 24.0cm



WERTHEIM
09.5654.14 14.5cm
09.5654.19 19.5cm
09.5654.22 22.5cm



SIMS
09.5660.20 20.0cm 09.5661.20
09.5660.23 23.0cm 09.5661.23

09.5661.23

09-026

Dressing Forceps EN

Anatomische Pinzetten DE

Pinzas de diseccion ES

11

TC - DRESSING & TISSUE FORCEPS

dagno
DIAGNOSURGI



STANDARD



STANDARD

- 11.5010.10 10.5cm
- 11.5010.11 11.5cm
- 11.5010.13 13.0cm
- 11.5010.14 14.5cm
- 11.5010.16 16.0cm
- 11.5010.18 18.0cm
- 11.5010.20 20.0cm
- 11.5010.23 23.0cm
- 11.5010.25 25.0cm
- 11.5010.30 30.0cm



NARROW

- 11.5012.10 10.5cm
- 11.5012.11 11.5cm
- 11.5012.13 13.0cm
- 11.5012.14 14.5cm
- 11.5012.16 16.0cm
- 11.5012.18 18.0cm
- 11.5012.20 20.0cm
- 11.5012.23 23.0cm
- 11.5012.25 25.0cm
- 11.5012.30 30.0cm



BONNEY
17.5cm



11.5046.17

1:2 T



11.5048.17



WANGENSTEEN



11.5058.15 15.0cm



11.5058.23 23.0cm



11.5058.25 25.0cm



ADSON STANDARD



11.5066.12 12.0cm

11.5066.15 15.0cm

11.5066.19 19.0cm

11.5066.19

11-027

EN Dressing Forceps

DE Anatomische Pinzetten

ES Pinzas de diseccion



TC - DRESSING & TISSUE FORCEPS



McINDOE
11.5070.15 15.0cm



CUSHING
11.5080.17 17.0cm



POTTS.SMITH
11.5084.18 18.0cm
11.5084.21 21.0cm
11.5084.25 25.0cm
11.5084.30 30.0cm



POTTS.SMITH
11.5084.18 18.0cm



GERALD
11.5094.18 18.0cm



TAYLOR
11.5104.17 17.5cm

11.5104.17

11-028

TC - DRESSING & TISSUE FORCEPS

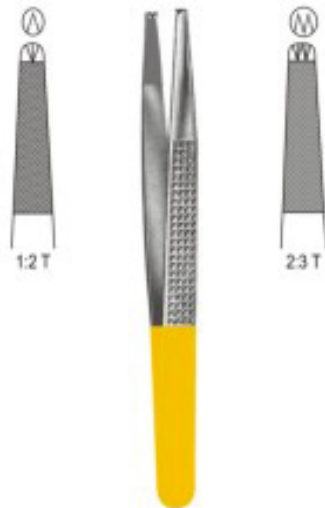

BONNEY (Heavy Patt.)
 11.5156.18 18.0cm 11.5158.18

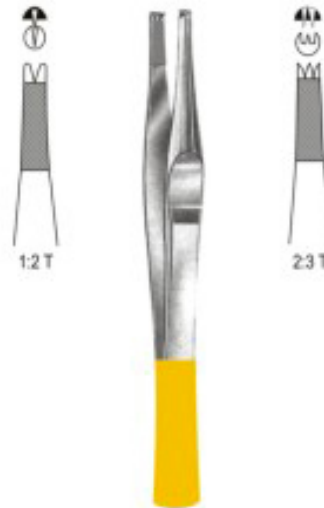

LANES
 11.5166.12 12.5cm 11.5168.12
 11.5166.15 15.5cm 11.5168.15
 11.5166.18 18.0cm 11.5168.18
 11.5166.20 20.0cm 11.5168.20

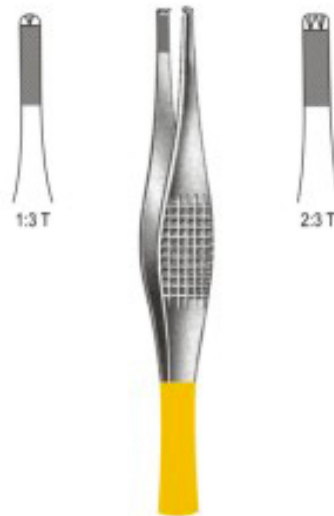

FERRIS-SMITH
 11.5172.18 18.0cm 11.5174.18

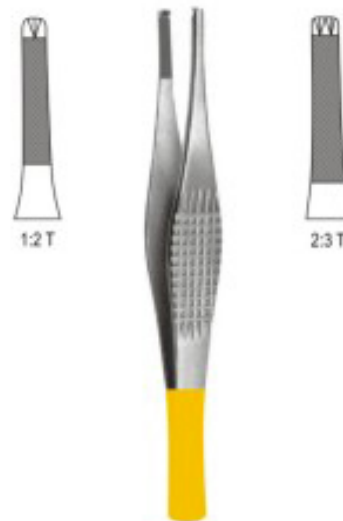

RAMSAY
 11.5178.18 18.0cm 11.5180.18

11.5180.18

11-029



TC - DRESSING & TISSUE FORCEPS



McINDOE
 11.5200.15 15.0cm



GILLIES
 11.5204.15 15.0cm



GERALD
 11.5218.18 18.0cm



CUSHING
 11.5222.17 17.5cm



CUSHING
 11.5224.17 17.5cm 11.5225.17



ADSON STANDARD
 11.5246.12 12.0cm
 11.5246.15 15.0cm

11.5246.15

11-030

TC - DRESSING & TISSUE FORCEPS



MICRO-ADSON
 11.5254.12 12.0cm
 11.5254.15 15.0cm



ADSON-BROWN
 11.5258.12 12.0cm



MICRO ADSON
 11.5302.12 12.0cm
 11.5302.15 15.0cm



Öehler
 11.5600.30 30.0cm

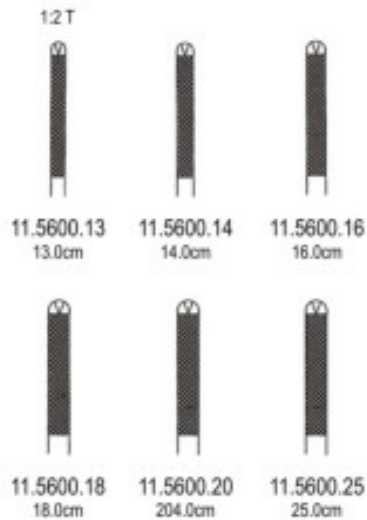

11.5600.30

11-031



TC - DRESSING & TISSUE FORCEPS



1.5
 2.4 T
 11.5610.15 15.0cm
 11.5610.20 20.0cm
 11.5610.24 24.0cm

DEBAKEY

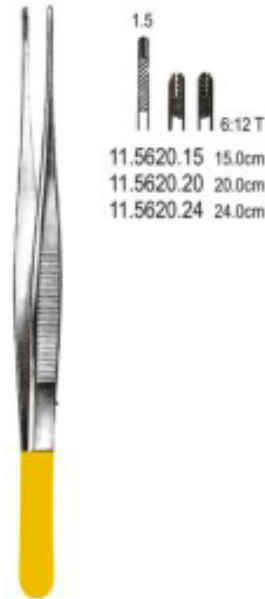

1.5
 6:12 T
 11.5620.15 15.0cm
 11.5620.20 20.0cm
 11.5620.24 24.0cm

DEBAKEY



2.0
 2.4 T
 11.5630.15 15.0cm
 11.5630.20 20.0cm
 11.5630.24 24.0cm
 2.7
 11.5632.15 15.0cm
 11.5632.20 20.0cm
 11.5632.24 24.0cm
 3.5
 11.5634.15 15.0cm
 11.5634.20 20.0cm
 11.5634.24 24.0cm

DEBAKEY



6:12 T
 11.5640.15 15.0cm
 11.5640.20 20.0cm
 11.5640.24 24.0cm
 2.0
 11.5642.15 15.0cm
 11.5642.20 20.0cm
 11.5642.24 24.0cm
 3.5
 11.5646.15 15.0cm
 11.5646.20 20.0cm
 11.5646.24 24.0cm

DEBAKEY

11.5646.24

11-032

Needle Holders EN

Nadelhalter DE

Porta-agujas ES

21

TC - SUTURE

dagno
DIAGNOSURGI



DERF
21.5012.12 12.5cm



WEBSTER
21.5024.13 13.0cm 21.5026.13
smooth



HALSEY
21.5030.13 13.0cm 21.5032.13
smooth



HEGAR-BAUMGARTNER
21.5040.12 12.5cm
21.5040.14 14.0cm



MAYO-HEGAR
21.5050.14 14.0cm
21.5050.15 15.0cm
21.5050.16 16.0cm
21.5050.18 18.0cm
21.5050.20 20.0cm
21.5050.22 22.0cm
21.5050.24 24.0cm
21.5050.26 26.0cm
21.5050.30 30.0cm

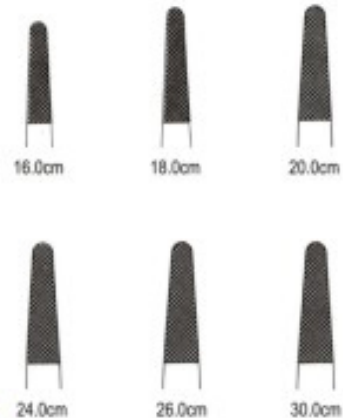

21.5051.30

21-033

EN Needle Holder

DE Nadelhalter

ES Porta-agujas

dagno
DIAGNOSURGI

TC - SUTURE



MAYO-HEGAR

21.5056.16 16.0cm
21.5056.18 18.0cm
21.5056.20 20.0cm



NEW ORLEANS

21.5058.18 18.0cm



CRILE-WOOD (NEWMAN)

21.5062.15 15.0cm
21.5062.18 18.0cm
21.5062.20 20.0cm
21.5062.23 23.0cm
21.5062.26 26.0cm



CRILE-WOOD

21.5066.13 13.0cm
21.5066.15 15.0cm
21.5066.18 18.0cm
21.5066.20 20.0cm
21.5066.23 23.0cm



HEGAR

21.5070.20 20.0cm
21.5070.24 24.0cm



HEANEY

21.5080.21 21.0cm
21.5080.24 24.0cm
21.5080.26 26.0cm

21.5080.26

21-034

Needle Holders EN

Nadelhalter DE

Porta-agujas ES

21

TC - SUTURE

dagno
DIAGNOSURGI

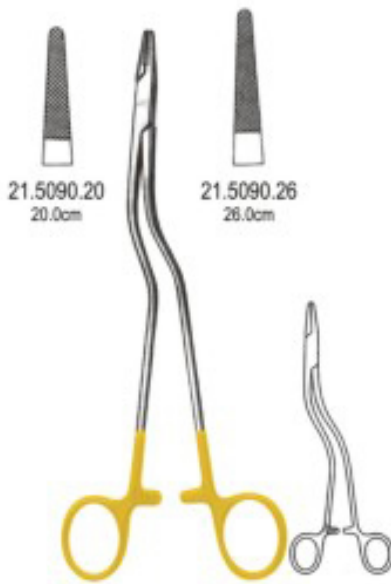

21.5090.20
20.0cm

21.5090.26
26.0cm

MASSON-LUETHY

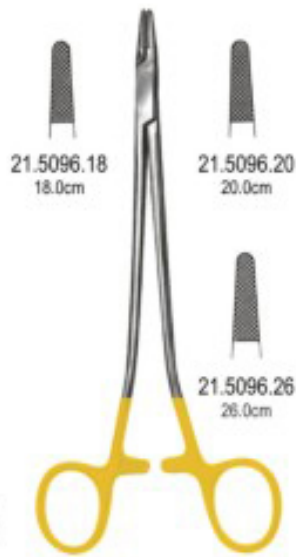

21.5096.18
18.0cm

21.5096.20
20.0cm

21.5096.26
26.0cm

SAROT

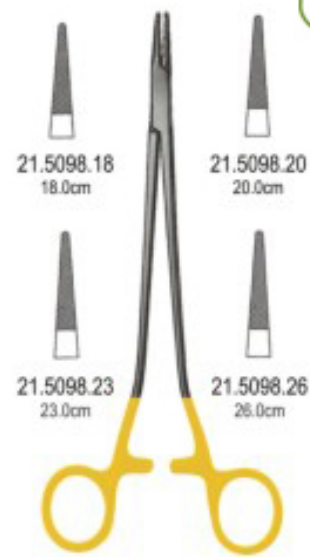

21.5098.18
18.0cm

21.5098.20
20.0cm

21.5098.23
23.0cm

21.5098.26
26.0cm

SAROT
Delicate



21.5106.20
20.0cm

Left

21.5106.23
23.0cm

21.5107.20
20.0cm

Right

21.5107.23
23.0cm

STRATTE

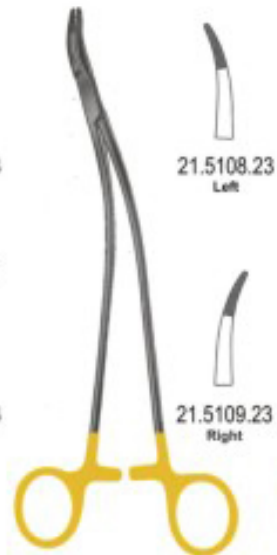

21.5108.23
Left

21.5109.23
Right

STRATTE
23.0cm



KILNER
21.5116.13 13.5cm
21.5116.16 16.5cm

21.5116.13

21-035

EN Needle Holder

DE Nadelhalter

ES Porta-agujas

dagno
DIAGNOSURGI

TC - SUTURE



21.5122.20
20.0cm

21.5122.26
26.0cm

21.5122.23
23.0cm

21.5122.30
30.0cm

BOZEMANN



FINOCCHIETTO
21.5136.18 18.0cm
21.5136.20 20.0cm
21.5136.27 27.0cm



MASSON
21.5140.20 20.0cm
21.5140.25 25.0cm
21.5140.27 27.0cm



DeBaKey
21.5142.37 37.0cm

21.5142.37

21-036

Needle Holders EN

Nadelhalter DE

Porta-agujas ES

21

TC - SUTURE

dagno
DIAGNOSURGI



WANGENSTEEN
21.5144.27 27.0cm



JAMISON
21.5150.23 23.5cm



M.G.H.(mass-general-hospital)
21.5156.17 17.0cm



GILLIES MINI
21.5158.14 14.0cm



GILLIES
21.5160.16 16.0cm
21.5161.16 16.0cm (left hand)



OLSEN-HEGAR
21.5164.16 16.0cm

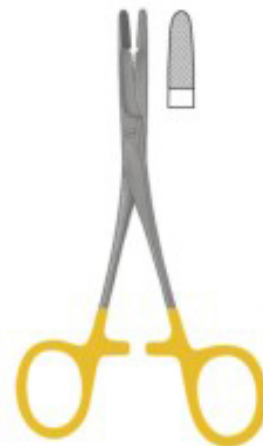

OLSEN-HEGAR
21.5172.17 17.0cm

21.5172.17

21-037

EN Needle Holder

DE Nadelhalter

ES Porta-agujas



TC - SUTURE



OLSEN-HEGAR
21.5174.14 14.0cm
21.5174.17 17.0cm



OLSEN-HEGAR
21.5178.12 12.0cm
21.5178.14 14.0cm
21.5178.18 18.0cm



CRILE
21.5180.15 15.0cm



TOENNIS
21.5186.18 18.0cm



LICHTENBERG
21.5190.20 20.0cm

21.5190.20

21-038

Micro-Needle Holders EN

Mikro-Nadelhalter DE

Micro-porta-agujas ES

21

TC - SUTURE

dagno
DIAGNOSURGI



MATHIEU

21.5200.14 14.0cm
21.5200.17 17.0cm
21.5200.20 20.0cm
21.5200.24 24.0cm



MATHIEU

21.5204.14 14.0cm
21.5204.17 17.0cm
21.5204.20 20.0cm



MATHIEU

21.5206.17 17.0cm
21.5206.20 20.0cm
21.5206.23 23.0cm



BARRAQUER

21.5210.16 16.0cm



ARRUGA

21.5214.14 14.0cm
21.5215.14 14.0cm



KALT

21.5220.14
14.0cm



KALT-ARRUGA

21.5224.14
14.0cm



CASTROVIEJO-KALT

21.5226.13
13.5cm

21.5226.13

21-039

EN Micro-Needle Holders

DE Mikro-Nadelhalter

ES Micro-porta-agujas

dagno
DIAGNOSURGI

TC - SUTURE



BOYNTON
21.5230.12
12.0cm



ARRUGA
21.5234.16 16.0cm
21.5235.16 16.0cm



STEVENSON
21.5240.11
11.0cm



STEVENS
21.5246.13 13.0cm
21.5246.15 15.0cm



WECKER
21.5250.15
15.0cm



BARRAQUER
21.5256.14
14.0cm

21.5256.14

21-040

Micro-Needle Holders EN

Mikro-Nadelhalter DE

Micro-porta-agujas ES

21

TC - SUTURE

dagno
DIAGNOSURGI



CASTROVIEJO
21.5260.09 9.0cm



CASTROVIEJO
21.5261.09 9.0cm



CASTROVIEJO
21.5262.09 9.0cm



CASTROVIEJO
21.5263.09 9.0cm



CASTROVIEJO
21.5262.14 14.0cm



CASTROVIEJO
21.5263.14 14.0cm



BARRAQUER
21.5266.10 10.0cm



BARRAQUER
21.5267.10 10.0cm

21.5267.10

21-041

EN Micro-Needle Holders

DE Mikro-Nadelhalter

ES Micro-porta-agujas

dagno
DIAGNOSURGI

TC - SUTURE



BARRAQUER-TROUTMAN
21.5270.10 10.0cm



BARRAQUER-TROUTMAN
21.5271.10 10.0cm



BARRAQUER
21.5276.14 14.0cm



BARRAQUER
21.5277.13 13.0cm



BARRAQUER
21.5280.11 11.0cm



BARRAQUER
21.5282.13 13.0cm

21.5282.13

21-042

Micro-Needle Holders EN

Mikro-Nadelhalter DE

Micro-porta-agujas ES

21

TC - SUTURE



CASTROVIEJO
21.5300.14 14.0cm 21.5302.14
21.5300.17 17.0cm 21.5302.17



CASTROVIEJO
21.5301.14 14.0cm 21.5303.14
21.5301.17 17.0cm 21.5303.17



CASTROVIEJO
21.5304.14 14.0cm 21.5306.14
21.5304.17 17.0cm 21.5306.17



CASTROVIEJO
21.5305.14 14.0cm 21.5307.14
21.5305.17 17.0cm 21.5307.17

21.5307.17

21-043

EN Micro-Needle Holders

DE Mikro-Nadelhalter

ES Micro-porta-agujas



TC - SUTURE



JACOBSON
21.5310.18 18.5cm
21.5310.21 21.0cm



JACOBSON
21.5314.18 18.5cm
21.5314.21 21.0cm



CASTROVIEJO
21.5320.10 10.0cm 21.5321.10



CASTROVIEJO
21.5324.10 10.0cm 21.5325.10

21.5325.10

21-044

Needle Holders EN

Nadelhalter DE

Porta-agujas ES

21

TC - SUTURE



INTRACARDIAC

			
21.5700.18 18.0cm	21.5700.20 20.0cm	21.5700.23 23.0cm	21.5700.26 26.0cm

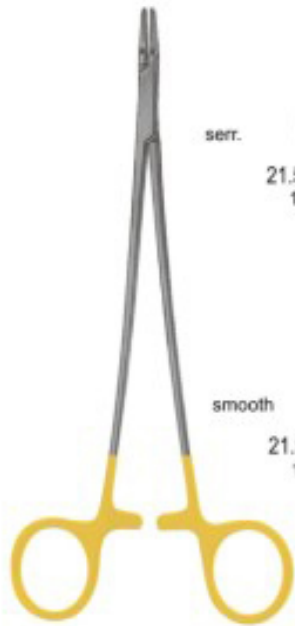

MICRO-RYDER

21.5710.26 26.0cm 21.5712.26

serr.					
	21.5710.13 13.0cm	21.5710.15 15.0cm	21.5710.18 18.0cm	21.5710.20 20.0cm	21.5710.23 23.0cm
smooth					
	21.5712.13 13.0cm	21.5712.15 15.0cm	21.5712.18 18.0cm	21.5712.20 20.0cm	21.5712.23 23.0cm

21.5712.23

21-045

EN Needle Holders

DE Nadelhalter

ES Porta-agujas



TC - SUTURE



FRENCH EYE (RYDER)



LEMMON



MICRO-VASCULAR

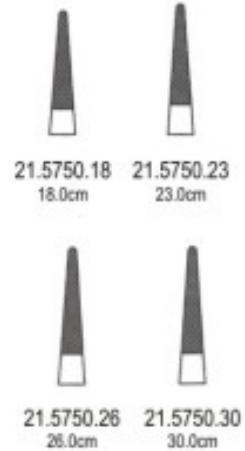

DeBakey

21.5750.30

21-046

Needle Holders EN

Nadelhalter DE

Porta-agujas ES

21

TC - SUTURE



serr. 21.5760.14
14.0cm

21.5760.15
15.0cm

21.5760.18
18.0cm

21.5760.20
20.0cm

smooth 21.5762.14
14.0cm

21.5762.15
15.0cm

21.5762.18
18.0cm

21.5762.20
20.0cm

EUFRATE-PASQUE



21.5770.18
18.0cm

PARELL



21.5780.14
14.0cm

SWEDSH



21.5790.18
18.0cm

SENNING

21.5790.18

21-047

EN Needle Holders

DE Nadelhalter

ES Porta-agujas



TC - SUTURE



21.5800.17
17.0cm

21.5800.19
19.0cm

MATHIEU-STILLE



21.5820.20
2.0cm

LANGENBECK



21.5830.16
16.0cm

21.5830.18
18.0cm

21.5830.20
20.0cm

LANGENBECK



21.5840.20
20.0cm

21.5840.23
23.0cm

ZWEIFEL

21.5840.23

21-048

Needle Holders EN

Nadelhalter DE

Porta-agujas ES

21

TC - SUTURE

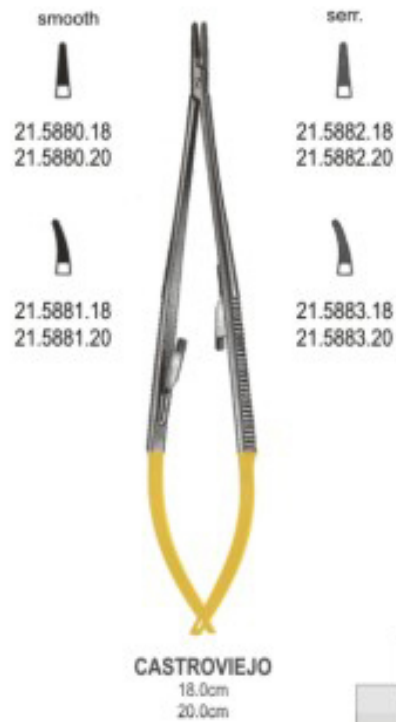

21.5883.20

21-049

21

EN Micro-Needle Holders

DE Mikro-Nadelhalter

ES Micro-porta-agujas

dagno
DIAGNOSURGI

TC - SUTURE



21.5890.24
24.0cm

GIANNINI

smooth



21.5900.13
13.0cm

serr.



21.5902.13
13.0cm



21.5901.13
13.0cm



21.5903.13
13.0cm

CASTROVIEJO

smooth



21.5910.13
13.0cm

serr.



21.5912.13
13.0cm

CASTROVIEJO

smooth



21.5920.18
18.0cm

serr.



21.5922.18
18.0cm

HEPP-SCHIEDL

21.5922.18

21-050

Micro-Needle Holders EN

Mikro-Nadelhalter DE

Micro-porta-agujas ES

21

TC - SUTURE

dagno
DIAGNOSURGI



MICRO-CASTROVIEJO

1.2	1.2	smooth	1.2	1.2
21.5930.14	14.0cm	21.5931.14	21.5932.14	14.0cm
1.2	1.2	serr.	1.2	1.2
21.5930.15	15.0cm	21.5931.15	21.5932.15	15.0cm



MICRO-CASTROVIEJO
(with catch lock)

1.2	1.2	smooth	1.2	1.2
21.5934.14	14.0cm	21.5935.14	21.5936.14	14.0cm
1.2	1.2	serr.	1.2	1.2
21.5934.15	15.0cm	21.5935.15	21.5936.15	15.0cm

21.5937.15

21-051

EN Micro-Needle Holders

DE Mikro-Nadelhalter





ES Micro-porta-agujas





dagno
DIAGNOSURGI

TC - SUTURE







MICRO-CASTROVIEJO





			smooth		
					
21.5970.18	21.5971.18	18cm		21.5972.18	21.5973.18
21.5970.21	21.5971.21	21cm		21.5972.21	21.5973.21
21.5970.23	21.5971.23	23cm		21.5972.23	21.5973.23

			serr.		
					
21.5974.18	21.5975.18	18cm		21.5976.18	21.5977.18
21.5974.21	21.5975.21	21cm		21.5976.21	21.5977.21
21.5974.23	21.5975.23	23cm		21.5976.23	21.5977.23



MICRO-CASTROVIEJO
(with catch lock)

			smooth		
					
21.5990.18	21.5991.18	18cm		21.5992.18	21.5993.18
21.5990.21	21.5991.21	21cm		21.5992.21	21.5993.21
21.5990.23	21.5991.23	23cm		21.5992.23	21.5993.23

			serr.		
					
21.5994.18	21.5995.18	18cm		21.5996.18	21.5997.18
21.5994.21	21.5995.21	21cm		21.5996.21	21.5997.21
21.5994.23	21.5995.23	23cm		21.5996.23	21.5997.23

21.5997.23

21-052

Wire Twisters EN

Drahts panzangen DE

Tensores de alambre ES

25

TC - BONE SURGERY



25.5690.18

BERRY



25.5700.17
17.0cm

25.5700.20
20.0cm

MATHIEU-BERRY

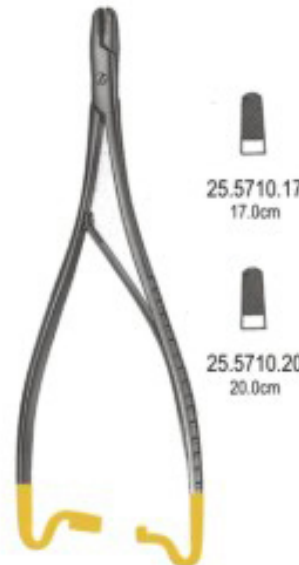

25.5710.17
17.0cm

25.5710.20
20.0cm

MAYO-HAUBERISSER



25.5720.16
16.0cm

25.5722.16
16.0cm

25.5724.16
16.0cm

25.5726.18
18.0cm

25.5728.18
18.0cm

MAYO-HAUBERISSER

25.5728.18

25-053

25

EN Wire Twisters, Flat Nose Pliers
DE Drahts pazzangen, Flachzangen
ES Tensores de alambre, Alicates planas



TC - BONE SURGERY



25.5782.18

25-054

Flat Nose Pliers, Wire Cutters **EN**
 Flachzangen, Seitenschneider **DE**
 Alicates planas, Alambre y agujas **ES**

25

TC - BONE SURGERY



18.0cm



parallel action



25.5784.01



25.5784.02



25.5784.03



14.0cm



25.5786.01



25.5786.02



25.5790.15
15.0cm



25.5800.23
23.0cm



25.5800.25
25.0cm



25.5810.16
16.0cm



25.5810.16

25-055

25

EN Wire Cutters
DE Seitenschneider
ES Alambre y agujas

dagno
DIAGNOSURGI

TC - BONE SURGERY



25.5820.18
18.0cm



25.5830.18 18.0cm
25.5830.22 22.0cm



25.5840.20
20.0cm



25.5850.16
16.0cm



25.5860.18
18.0cm

25.5860.18

25-056

Wire Cutters EN

Seltenschneider DE

Alambre y agujas ES

25

TC - BONE SURGERY



25.5870.22
22.0cm



25.5880.24
24.0cm



25.5890.24
24.0cm



KIRSCHNER
25.5900.47 47.0cm

25.5900.47

25-057

EN Nasal Rasps, Bone Files, Antrum Rasps
 DE Knochenfellen, Nasenraspeln, Antrumraspeln
 ES Limas para huesos, escofinas nasales, escofinas para el antro



TC - RHINOLOGY



LEWIS
18.0cm



45.5674.18
fine



45.5676.18
coarse



MILLER



45.5680.18
18.0cm



45.5681.18
18.0cm



COTTLE
18.0cm



45.5686.01



45.5686.02



45.5686.03



45.5686.04



45.5686.05



45.5686.06



45.5686.07



45.5686.08



45.5686.09



45.5686.10

45.5688.10

45-058

Antrum and Nasal Rasps EN
Antrum und Nasenraspeln DE
Escofinas para el antro y nasales ES

45

TC - RHINOLOGY



FOMON
20.0cm



45.5698.01



45.5698.02



45.5698.03



45.5698.04



45.5698.05



45.5698.05

45-059

TC - INTESTINAL & STOMACH



ALLIS



BABCOCK



DUVAL



52.5192.20

45-060